



NVIDIA DGX A100

User Guide

Table of Contents

Chapter 1. Introduction to the NVIDIA DGX A100 System.....	1
1.1. Hardware Overview.....	1
1.1.1. DGX A100 Models and Component Descriptions.....	2
1.1.2. Mechanical Specifications.....	3
1.1.3. Power Specifications.....	4
1.1.3.1. Support for N+N Redundancy.....	4
1.1.4. DGX A100 Locking Power Cord Specification.....	4
1.1.5. Using the Locking Power Cords.....	5
1.1.6. Environmental Specifications.....	7
1.1.7. Front Panel Connections and Controls.....	7
1.1.7.1. With a Bezel.....	7
1.1.7.2. With the Bezel Removed.....	8
1.1.8. Rear Panel Modules.....	8
1.1.9. Motherboard Connections and Controls.....	9
1.1.10. Motherboard Tray Components.....	10
1.1.11. GPU Tray Components.....	10
1.2. Network Connections, Cables, and Adaptors.....	11
1.2.1. Network Ports.....	11
1.2.2. Supported Network Cables and Adaptors.....	13
1.3. DGX A100 System Topology.....	13
1.4. DGX OS Software.....	14
1.5. Additional Documentation.....	14
1.6. Customer Support.....	15
Chapter 2. Connecting to the DGX A100.....	16
2.1. Connecting to the Console.....	16
2.1.1. Direct Connection.....	16
2.1.2. Remote Connection through the BMC.....	18
2.2. SSH Connection to the OS.....	20
Chapter 3. First Boot Setup.....	21
3.1. Setting up the System.....	21
3.2. Post Setup Tasks.....	24
3.2.1. Obtaining Software Updates.....	24
3.2.2. Enabling the srp Daemon.....	24
Chapter 4. Quick Start and Basic Operation.....	25
4.1. Installation and Configuration.....	25

4.2. Registering Your DGX A100.....	25
4.3. Obtaining an NGC Account.....	26
4.4. Turning DGX A100 On and Off.....	26
4.4.1. Startup Considerations.....	26
4.4.2. Shutdown Considerations.....	26
4.5. Verifying Functionality - Quick Health Check.....	26
4.6. Running the Pre-flight Test.....	27
4.7. Running NGC Containers with GPU Support.....	28
4.7.1. Using Native GPU Support.....	28
4.7.2. Using the NVIDIA Container Runtime for Docker.....	28
4.8. Managing CPU Mitigations.....	29
4.8.1. Determining the CPU Mitigation State of the DGX System.....	29
4.8.2. Disabling CPU Mitigations.....	30
4.8.3. Re-enabling CPU Mitigations.....	30
Chapter 5. Additional Features and Instructions.....	31
5.1. Managing the DGX Crash Dump Feature.....	31
5.1.1. Using the Script.....	31
5.1.2. Connecting to Serial Over LAN to View the Console.....	31
Chapter 6. Managing the DGX A100 Self-Encrypting Drives.....	33
6.1. Overview.....	33
6.2. Installing the Software.....	34
6.3. Configuring Trusted Computing.....	34
6.3.1. Determining Whether Drives Support SID.....	35
6.3.2. Enabling the TPM and Preventing the BIOS from Sending Block SID Requests.....	35
6.4. Initializing the System for Drive Encryption.....	36
6.5. Enabling Drive Locking.....	36
6.6. Initialization Examples.....	36
6.6.1. Example 1: Passing in the JSON File.....	37
6.6.1.1. Determining Which Drives Can be Managed as Self-Encrypting.....	37
6.6.1.2. Creating the Drive/Password Mapping JSON Files and Using it to Initialize the System.....	38
6.6.2. Example 2: Generating Random Passwords.....	39
6.6.3. Example 3: Specifying Passwords One at a Time When Prompted.....	39
6.7. Disabling Drive Locking.....	39
6.8. Enabling Drive Locking.....	39
6.9. Exporting the Vault.....	40
6.10. Erasing Your Data.....	40
6.11. Clearing the TPM.....	40

6.12. Changing Disk Passwords, Adding Disks, or Replacing Disks.....	41
6.13. Recovering From Lost Keys.....	41
Chapter 7. Network Configuration.....	42
7.1. Configuring Network Proxies.....	42
7.1.1. For the OS and Most Applications.....	42
7.1.2. For apt.....	42
7.1.3. For Docker.....	43
7.2. Configuring Docker IP Addresses.....	43
7.3. Open Ports.....	44
7.4. Connectivity Requirements for NGC Containers.....	44
7.5. Configuring a Static IP Address for the BMC.....	45
7.5.1. Configuring a BMC Static Address by Using ipmitool.....	45
7.5.2. Configuring a BMC Static IP Address by Using the System BIOS.....	46
7.6. Configuring a BMC Static IP Address for the Network Ports.....	46
7.7. Switching Between InfiniBand and Ethernet.....	47
7.7.1. Starting the Mellanox Software Tools and Determining the Current Port Configuration.....	48
7.7.2. Switching the Port Configuration.....	48
Chapter 8. Configuring Storage.....	50
8.1. Setting Filesystem Quotas.....	51
8.2. Switching Between RAID 0 and RAID 5.....	51
8.3. Configuring Support for Custom Drive Partitioning.....	52
Chapter 9. Updating and Restoring the Software.....	53
9.1. Updating the DGX A100 Software.....	53
9.1.1. Connectivity Requirements for Software Updates.....	53
9.1.2. Update Instructions.....	54
9.2. Restoring the DGX A100 Software Image.....	54
9.2.1. Obtaining the DGX A100 Software ISO Image and Checksum File.....	55
9.2.2. Remotely Reimaging the System.....	55
9.2.3. Creating a Bootable Installation Medium.....	56
9.2.3.1. Creating a Bootable USB Flash Drive by Using the dd Command.....	57
9.2.3.2. Creating a Bootable USB Flash Drive by Using Akeo Rufus.....	58
9.3. Reimaging the System from a USB Flash Drive.....	59
9.4. Installation Options.....	59
9.4.1. Retaining the RAID Partition While Installing the OS.....	60
9.4.2. Advanced Installation Option (Encrypted Root - DGX OS 5 or Later).....	60
9.4.3. Boot into Live Environment (DGX OS 5 or Later).....	61
9.4.4. Check Disc for Defects (DGX OS 5 or Later).....	61

Chapter 10. Using the BMC.....	62
10.1. Connecting to the BMC.....	62
10.2. Overview of BMC Controls.....	63
10.3. Common BMC Tasks.....	65
10.3.1. Changing the BMC Login Credentials.....	65
10.3.2. Using the Remote Console.....	66
10.3.3. Setting Up Active Directory or LDAP/E-Directory.....	67
10.3.6. Configuring Platform Event Filters.....	73
10.3.7. Uploading or Generating SSL Certificates.....	73
10.3.7.1. Viewing the SSL Certificate.....	74
10.3.7.2. Generating the SSL Certificate.....	74
10.3.7.3. Uploading the SSL Certificate.....	76
10.3.7.4. Updating the SBIOS Certificate.....	76
Chapter 11. SBIOS Settings.....	80
11.1. Accessing the SBIOS Setup.....	80
11.2. Configuring the Boot Order.....	81
11.3. Configuring the local terminal to access the SBIOS settings screen.....	82
If using the IPMI SOL protocol:.....	83
For Linux desktop users, set the character encoding:.....	83
Power on or Reboot the system using one of the following interfaces, depending on what the state of the system is:.....	83
Chapter 12. Multi-Instance GPU.....	84
Chapter 13. Security.....	85
13.1. User Security Measures.....	85
13.1.1. Securing the BMC Port.....	85
13.2. System Security Measures.....	85
13.2.1. Secure Flash of DGX A100 Firmware.....	85
13.2.1.1. Encryption.....	85
13.2.1.2. Signing.....	86
13.2.1.3. NVSM Security.....	86
13.3. Secure Data Deletion.....	86
13.3.1. Prerequisites.....	86
13.3.2. Instructions.....	86
Chapter 14. Redfish APIs Support.....	88
14.1. Supported Redfish Features.....	88
Appendix A. Installing Software on Air-Gapped DGX A100 Systems.....	90
A.1. Installing NVIDIA DGX A100 Software.....	90

A.2. Reimaging the System.....	90
A.3. Creating a Local Mirror of the NVIDIA and Canonical Repositories.....	91
A.4. Creating the Mirror in a DGX OS 4 System.....	91
A.5. Configuring the Target Air-Gapped DGX OS 4 System.....	93
A.6. Configuring the Target Air-Gapped DGX OS 5 System.....	95
A.7. Installing Docker Containers.....	96
Appendix B. Safety.....	98
B.1. Safety Information.....	98
B.2. Safety Warnings and Cautions.....	98
B.3. Intended Application Uses.....	100
B.4. Site Selection.....	100
B.5. Equipment Handling Practices.....	100
B.6. Electrical Precautions.....	101
B.7. System Access Warnings.....	102
B.8. Rack Mount Warnings.....	103
B.9. Electrostatic Discharge.....	103
B.10. Other Hazards.....	104
Appendix C. Compliance.....	106
C.1. United States.....	106
C.2. United States/Canada.....	106
C.3. Canada.....	107
C.4. CE.....	107
C.5. Australia and New Zealand.....	108
C.6. Brazil.....	108
C.7. Japan.....	108
C.8. South Korea.....	111
C.9. China.....	112
C.10. Taiwan.....	114
C.11. Russia/Kazakhstan/Belarus.....	115
C.12. Israel.....	116
C.13. India.....	116
C.14. South Africa.....	117
C.15. Great Britain (England, Wales, and Scotland).....	117

List of Tables

Table 1. Model Differentiation.....	2
Table 2. Component Description.....	3
Table 3. Mechanical Specifications.....	3
Table 4. Power Specifications.....	4
Table 5. Motherboard Controls.....	9
Table 6. Network Port Mapping.....	12
Table 7. Open Ports.....	44
Table 8. BMC Main Controls.....	64
Table 9. BMC Main Controls.....	75

Chapter 1. Introduction to the NVIDIA DGX A100 System

The NVIDIA DGX™ A100 System is the universal system purpose-built for all AI infrastructure and workloads, from analytics to training to inference. The system is built on eight NVIDIA A100 Tensor Core GPUs.



This document is for users and administrators of the DGX A100 system.

1.1. Hardware Overview

This section provides information about the hardware in DGX A100.

1.1.1. DGX A100 Models and Component Descriptions

There are two models of the NVIDIA DGX A100 system: the NVIDIA DGX A100 640GB system and the NVIDIA DGX A100 320GB system.

Model Differentiation

Table 1. Model Differentiation

Component	NVIDIA DGX A100 640GB System	NVIDIA DGX A100 320GB System
GPU	Qty 8 NVIDIA A100 GPUs Third-generation NVLinks	Qty 8 NVIDIA A100 GPUs Third-generation NVLinks
Total GPU Memory	640 GB	320 GB
NVIDIA NVSwitch	Qty 6 Second generation (2x faster than first generation)	Qty 6 Second generation (2x faster than first generation)
Networking	Up to 10 (Factory ship config) NVIDIA ConnectX-6 or ConnectX-7 InfiniBand/200 Gb/s Ethernet	Up to 9 (Factory ship config) NVIDIA ConnectX-6 or ConnectX-7 IB/200 Gb/s Ethernet (Optional Add-on: Second dual- port 200 Gb/s Ethernet)
CPU	2 AMD Rome, 128 cores total	2 AMD Rome, 128 cores total
System Memory	2 TB (Factory ship config)	1 TB (Factory ship config) (Optional Add-on: 1 TB to get 2 TB max.)
Storage	30 TB (Factory ship config) U.2 NVMe Drives (Optional drive upgrade to 60 TB)	15 TB (Factory ship config) U.2 NVMe Drives (Optional Add-on: 15 TB to get 30 TB max.) Optional drive upgrade to 60 TB)

Component Description

Table 2. Component Description

Component	Description
GPU	NVIDIA A100 GPU
CPU	2x AMD EPYC 7742 CPU w/64 cores
NVSwitch	600 GB/s GPU-to-GPU bandwidth
Storage (OS)	1.92 TB NVMe M.2 SSD (ea) in RAID 1 array
Storage (Data Cache)	3.84 TB NVMe U.2 SED (ea) in RAID 0 array (Optional 7.68 TB NVMe U.2. SEDs)
Network (Cluster) card	NVIDIA ConnectX-6 or ConnectX-7 Single Port InfiniBand (default): Up to 200Gbps Ethernet: 200GbE, 100GbE, 50GbE, 40GbE, 25GbE, and 10GbE
Network (Storage) card	NVIDIA ConnectX-6 or ConnectX-7 Dual Port Ethernet (default): 200GbE, 100GbE, 50GbE, 40GbE, 25GbE, and 10GbE InfiniBand: Up to 200Gbps
System Memory (DIMM)	1 TB per 16 DIMMs
BMC (out-of-band system management)	1 GbE RJ45 interface Supports IPMI, SNMP, KVM, and Web UI
In-band system management	1 GbE RJ45 interface
Power Supply	3 kW

1.1.2. Mechanical Specifications

Here is some information about mechanical specifications.

Table 3. Mechanical Specifications

Feature	Description
Form Factor	6U Rackmount
Height	10.4" (264 mm)
Width	19" (482.3 mm) max

Feature	Description
Depth	35.3" (897.1 mm) max
System Weight	271.5 lbs (123.16 kg) max

1.1.3. Power Specifications

The DGX A100 system contains six power supplies with balanced distribution of the power load.

Table 4. Power Specifications

Input	Specification for Each Power Supply
200-240 volts AC	6.5 kW max. 3000 W @ 200-240 V, 16 A, 50-60 Hz

1.1.3.1. Support for N+N Redundancy

The DGX A100 includes six power supply units (PSU) configured for 3+3 redundancy. If three PSUs fail, the system will continue to operate at full power with the remaining three PSUs.



Note:

- ▶ If only two PSUs are working, the GPUs will not be available but the server will still boot. This is to allow you to gather debug or system logs or other data from the cache SSDs.
- ▶ If only one PSU is working, troubleshoot the cause for the loss of power from the other PSUs and correct. If faulty PSUs need to be replaced, shut the system down and install working PSUs.

1.1.4. DGX A100 Locking Power Cord Specification

The DGX A100 is shipped with a set of six (6) locking power cords that have been qualified for use with the DGX A100 to ensure regulatory compliance.

The following locking power cord types are approved:

- ▶ Switch-locking for the PSU side
- ▶ Twist-locking for the PSU side



WARNING: To avoid electric shock or fire, only use the NVIDIA-provided power cords to connect power to the DGX A100. For more details, see [Electrical Precautions](#).

Power Cord Specification

Power Cord Feature	Specification
Electrical	250VAC, 16A
Plug Standard	C19/C20
Dimension	1200mm length
Compliance	Cord: UL62, IEC60227 Connector/Plug: IEC60320-1

1.1.5. Using the Locking Power Cords

This section provides information about how to use the locking power cords.

Locking and Unlocking the PDU Side

Power Distribution Unit side

- ▶ To INSERT, push the cable into the PDU socket.
- ▶ To REMOVE, press the clips together and pull the cord out of the socket.

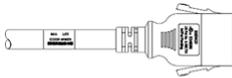

Locking/Unlocking the PSU Side (Cords with Switch-Lock Mechanism)

Power Supply (System) side - Switch locking

- ▶ To INSERT or REMOVE make sure the cable is UNLOCKED and push/ pull into/out of the socket.

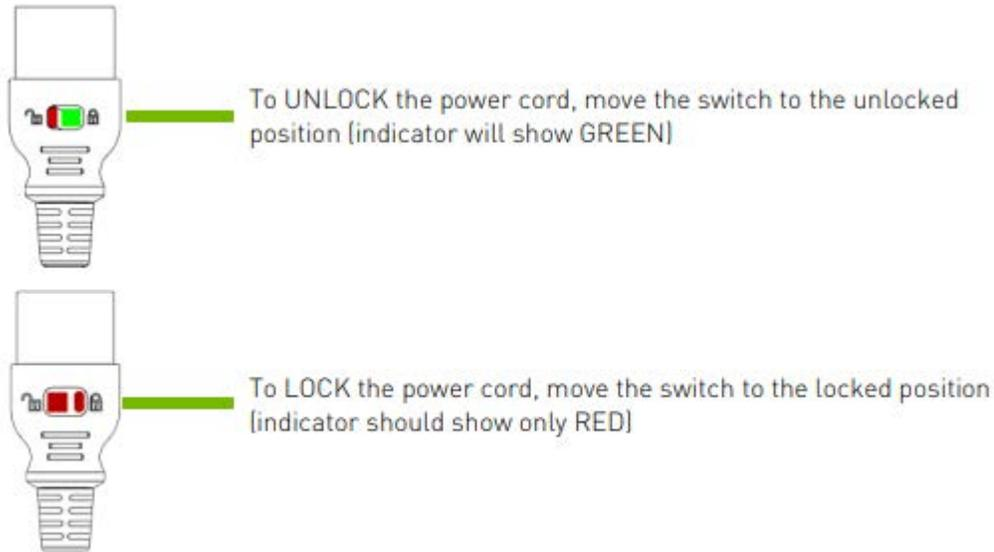

Locking/Unlocking the PSU Side (Cords with Twist-Lock Mechanism)

Power Supply (System) side - Twist locking

- ▶ To INSERT or REMOVE make sure the cable is UNLOCKED and push/ pull into/out of the socket.

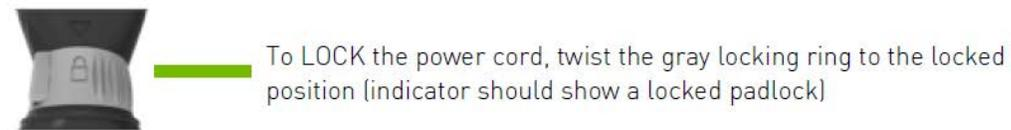
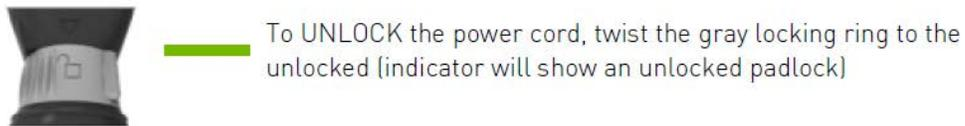

1.1.6. Environmental Specifications

Here are the environmental specifications for your DGX A100 system.

Feature	Specification
Operating Temperature	5° C to 30° C (41° F to 86° F)
Relative Humidity	20% to 80% non-condensing
Airflow	840 CFM @ 80% fan PWM
Heat Output	22,179 BTU/hr

1.1.7. Front Panel Connections and Controls

This section provides information about the front panel, connections, and controls of the DGX A100 system.

1.1.7.1. With a Bezel

Here is an image of the DGX A100 system with a bezel.

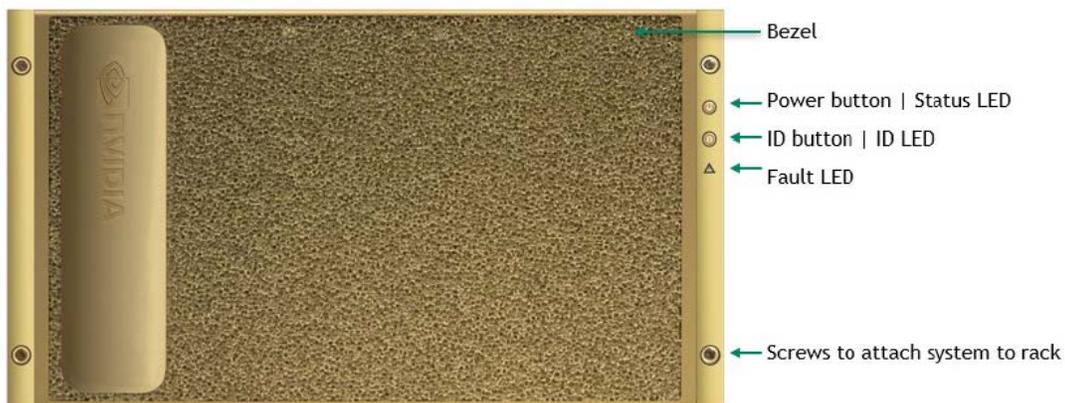

Control	Description
Power Button	Press to turn the DGX A100 system On or Off. <ul style="list-style-type: none"> ▶ Green flashing (1 Hz): Standby (BMC booted) ▶ Green flashing (4 Hz): POST in progress ▶ Green solid On: Power On
ID Button	Press to cause the button blue LED to turn On or blink (configurable through the BMC) as an identifier during servicing.

Control	Description
	Also causes an LED on the back of the unit to flash as an identifier during servicing.
Fault LED	Amber On: System or component faulted

1.1.7.2. With the Bezel Removed

Here is an image of the DGX A100 system with a bezel.

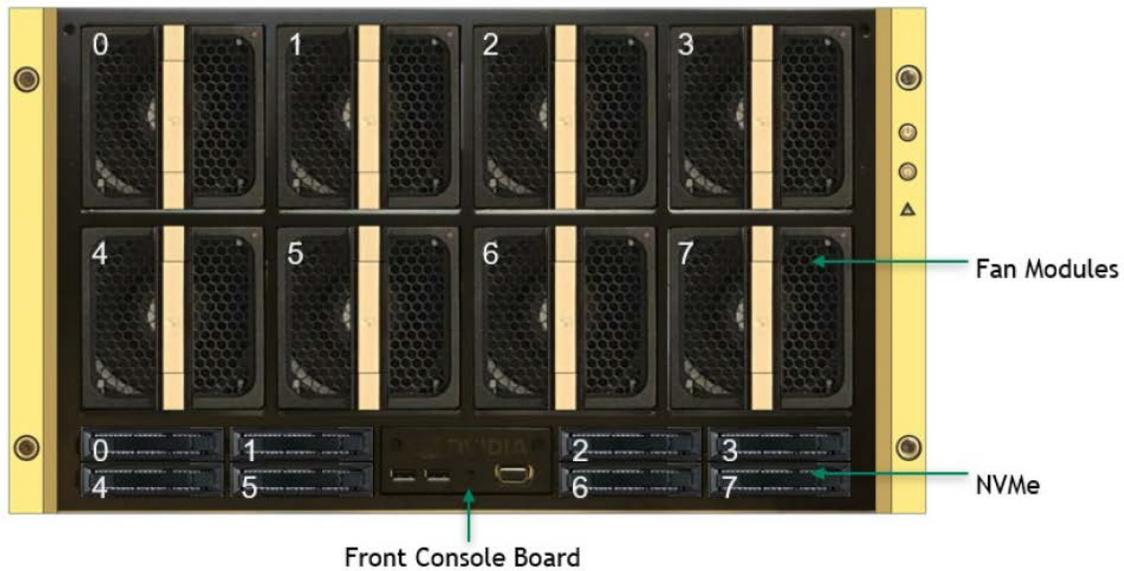

Important: Refer to [Turning DGX A100 On and Off](#) for instructions on how to properly turn the system on or off.

1.1.8. Rear Panel Modules

Here is an image that shows the rear panel modules on DGX A100.

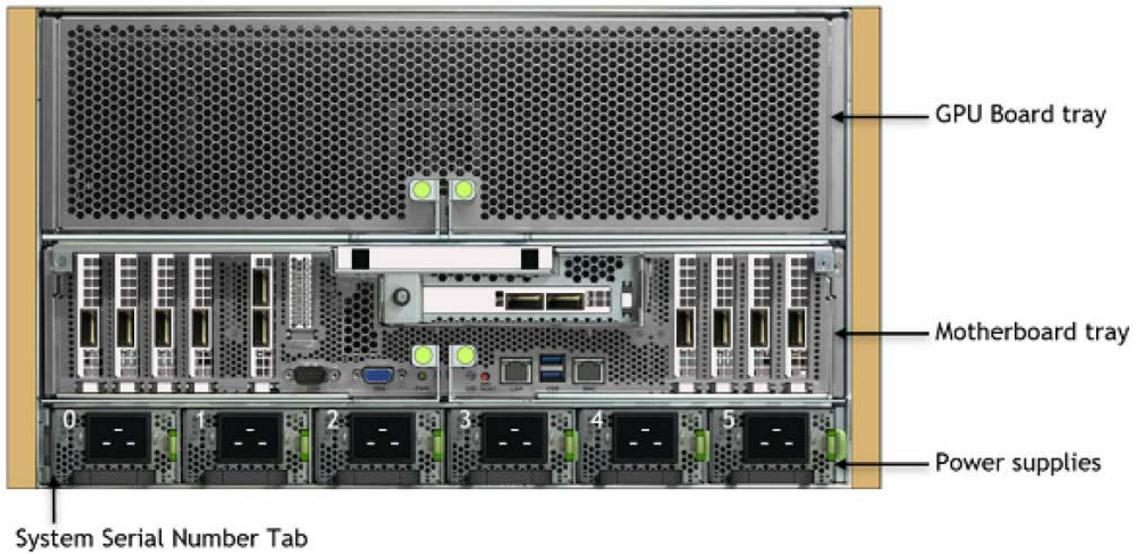

1.1.9. Motherboard Connections and Controls

Here is an image that shows the motherboard connections and controls in a DGX A100 system.

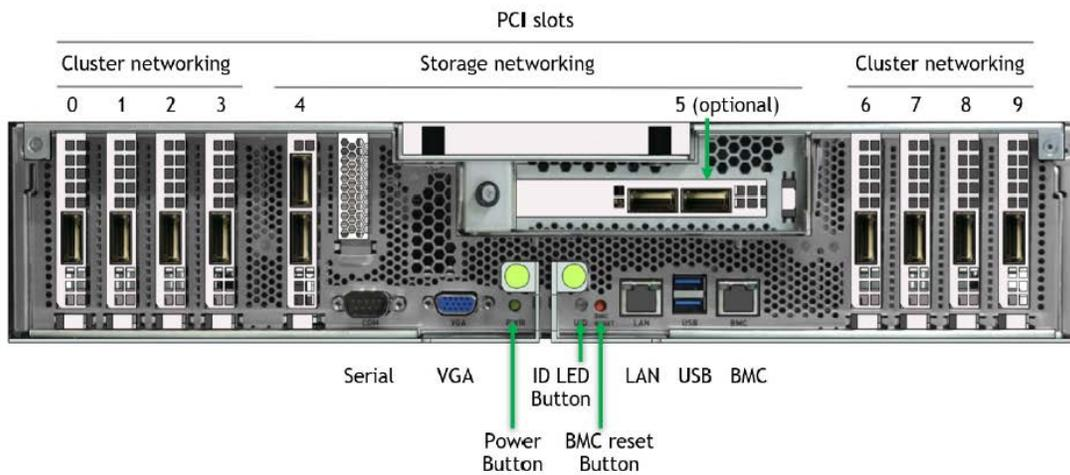

Table 5. Motherboard Controls

Control	Description
Power Button	Press to turn the system On or Off.

Control	Description
ID LED Button	Blinks when ID button is pressed from the front of the unit as an aid in identifying the unit needing servicing.
BMC Reset button	Press to manually reset the BMC.

See [Network Connections, Cables, and Adaptors](#) for details on the network connections.

1.1.10. Motherboard Tray Components

Here is an image that shows the motherboard tray components in DGX A100.



1.1.11. GPU Tray Components

Here is an image of the GPU tray components in a DGX A100 system.

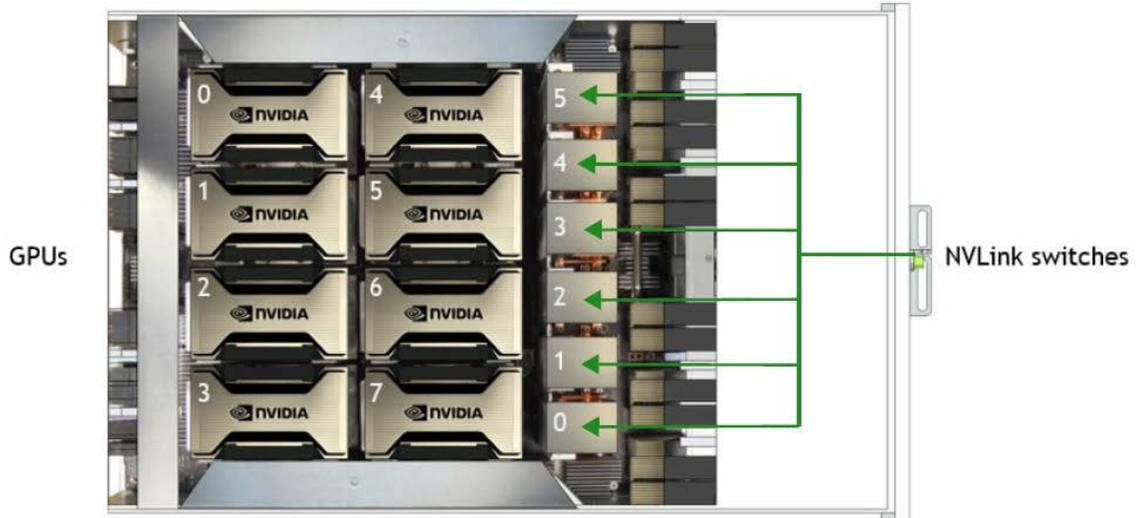

1.2. Network Connections, Cables, and Adaptors

This section provides information about network connections, cables, and adaptors.

1.2.1. Network Ports

Here is an image that shows the network ports on a DGX A100 system.

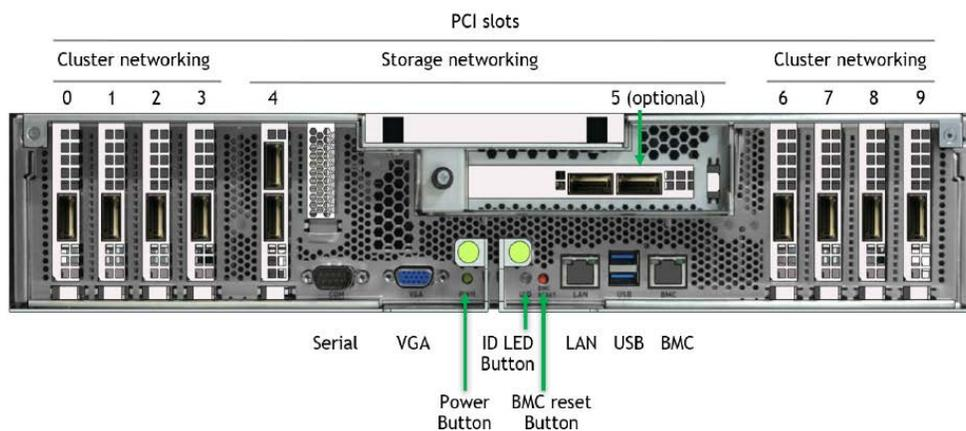

Table 6. Network Port Mapping

Slot	PCI Bus	Port Designation			RDMA		
		Default			Optional	Slot 5 Not Populated	Slot 5 Populated
		Pre-DGS OS 5	DGX OS 5 and later				
0	4b:00.0	ib2	ibp75s0	enp75s0	mlx5_2	mlx5_2	
1	54:00.0	ib3	ibp84s0	enp84s0	mlx5_3	mlx5_3	
2	ba:00.0	ib6	ibp186s0	enp186s0	mlx5_6	mlx5_8	
3	cc:00.0 ¹ ca:00.0 ²	ib7	ibp204s0a ³ ibp202s0b ⁴	enp204s0a ⁵ enp202s0b ⁶	mlx5_7	mlx5_9	
4 port 0 (top)	e1:00.0	enp225s0f0		(see note)	mlx5_8	mlx5_10	
4 port 1 (bottom)	e1:00.1	enp225s0f1		(see note)	mlx5_9	mlx5_11	
5 port 0 (left)	61:00.0	enp97s0f0		(see note)	-	mlx5_4	
5 port 1 (right)	61:00.1	enp97s0f1		(see note)	-	mlx5_5	
6	0c:00.0	ib0	ibp12s0	enp12s0	mlx5_0	mlx5_0	
7	12:00.0	ib1	ibp18s0	enp18s0	mlx5_1	mlx5_1	
8	8d:00.1	ib4	ibp141s0	enp141s0	mlx5_4	mlx5_6	
9	94:00.0	ib5	ibp148s0	enp148s0	mlx5_5	mlx5_7	
LAN	e2:00.0	enp226s0		N/A			



Note: The `enp37s0f3u1u3c2` interface or `bmc_redfish0` is recognized by the OS and may be listed in response to such commands as `ifconfig` or `ip addr`. This interface is reserved for future support of BMC communication using Redfish APIs and is not available for configuration.



Note: The Optional column lists the port designations after reconfiguring the default InfiniBand ports to Ethernet.

When switching from the default Ethernet to InfiniBand, the InfiniBand port designations will vary depending on changes made to the other ports.

¹ Based on systems updated with DGX A100 Firmware Update Container 20.10.9 or later

³ Based on systems updated with DGX A100 Firmware Update Container 20.10.9 or later

⁵ Based on systems updated with DGX A100 Firmware Update Container 20.10.9 or later

² Based on systems updated with DGX A100 Firmware Update Container 20.05.12.3 or earlier

⁴ Based on systems updated with DGX A100 Firmware Update Container 20.05.12.3 or earlier

⁶ Based on systems updated with DGX A100 Firmware Update Container 20.05.12.3 or earlier

1.2.2. Supported Network Cables and Adaptors

The DGX A100 system is not shipped with network cables or adaptors. You will need to purchase supported cables or adaptors for your network.

The ConnectX-6 or ConnectX-7 firmware determines which cables and adaptors are supported. For a list of cables and adaptors compatible with the NVIDIA ConnectX cards installed in the DGX A100 system,

1. Visit the [Mellanox Firmware Release](#) page.
2. From the left navigation menu, select the ConnectX model and corresponding firmware included in the DGX A100.
3. Select Firmware Compatible Products.

1.3. DGX A100 System Topology

Here is an image of the DGX A100 system topology.

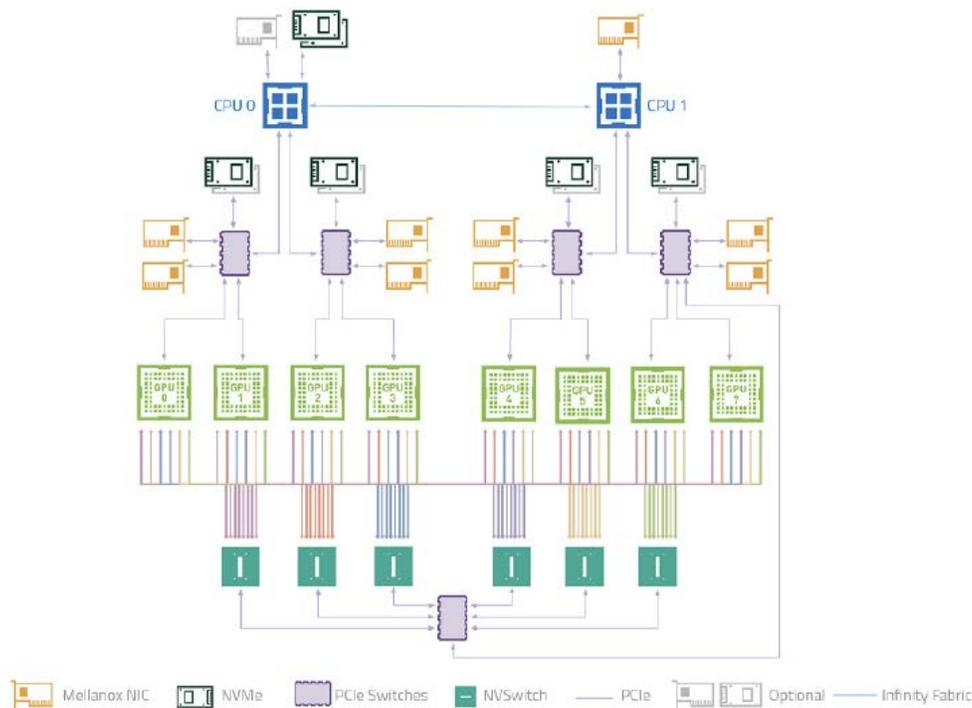

1.4. DGX OS Software

The DGX A100 system comes pre-installed with a DGX software stack incorporating the following components:

- ▶ An Ubuntu server distribution with supporting packages.
- ▶ The following system management and monitoring software:
 - ▶ NVIDIA System Management (NVSM)
Provides active health monitoring and system alerts for NVIDIA DGX nodes in a data center. It also provides simple commands for checking the health of the DGX A100 system from the command line.
 - ▶ Data Center GPU Management (DCGM)
This software enables node-wide administration of GPUs and can be used for cluster and data-center level management.
- ▶ DGX A100 system support packages.
- ▶ The NVIDIA GPU driver
- ▶ Docker Engine
- ▶ NVIDIA Container Toolkit
- ▶ Mellanox OpenFabrics Enterprise Distribution for Linux (MOFED)
- ▶ Mellanox Software Tools (MST)
- ▶ cachefilesd (daemon for managing cache data storage)

1.5. Additional Documentation

This section provides links to additional documentation.

- ▶ [MIG User Guide](#)
The new Multi-Instance GPU (MIG) feature allows the NVIDIA A100 GPU to be securely partitioned into up to seven separate GPU Instances for CUDA applications.
- ▶ [NGC Container Registry for DGX](#)
How to access the NGC container registry for using containerized deep learning GPU-accelerated applications on your DGX A100 system.
- ▶ [NVSM Software User Guide](#)
Contains instructions for using the NVIDIA System Management software.
- ▶ [DCGM Software User Guide](#)
Contains instructions for using the Data Center GPU Manager software.

1.6. Customer Support

Contact NVIDIA Enterprise Support for assistance in reporting, troubleshooting, or diagnosing problems with your DGX A100 system. Also contact NVIDIA Enterprise Support for assistance in moving the DGX A100 system.

- ▶ For contracted Enterprise Support questions, you can send an email to enterprisesupport@nvidia.com.
- ▶ For additional details about how to obtain support, go to [NVIDIA Enterprise Support](#).

Our support team can help collect appropriate information about your issue and involve internal resources as needed.

Chapter 2. Connecting to the DGX A100

This section provides information about how to connect to the DGX A100 system.

2.1. Connecting to the Console

Connect to the DGX A100 console using either a direct connection or a remote connection through the BMC.



CAUTION: Connect directly to the DGX A100 console if the DGX A100 system is connected to a 172.17.xx.xx subnet.

DGX OS Server software installs Docker Engine which uses the 172.17.xx.xx sub-net by default for Docker containers. If the DGX A100 system is on the same sub-net, you will not be able to establish a network connection to the DGX A100 system.

Refer to [Configuring Docker IP Addresses](#) for instructions on how to change the default Docker network settings.

2.1.1. Direct Connection

At the front or the back of the DGX A100 system, you can connect a display to the VGA connector and a keyboard to any of the USB ports.



Note: The display resolution must be 1440x900 or lower.

DGX A100 Server Front

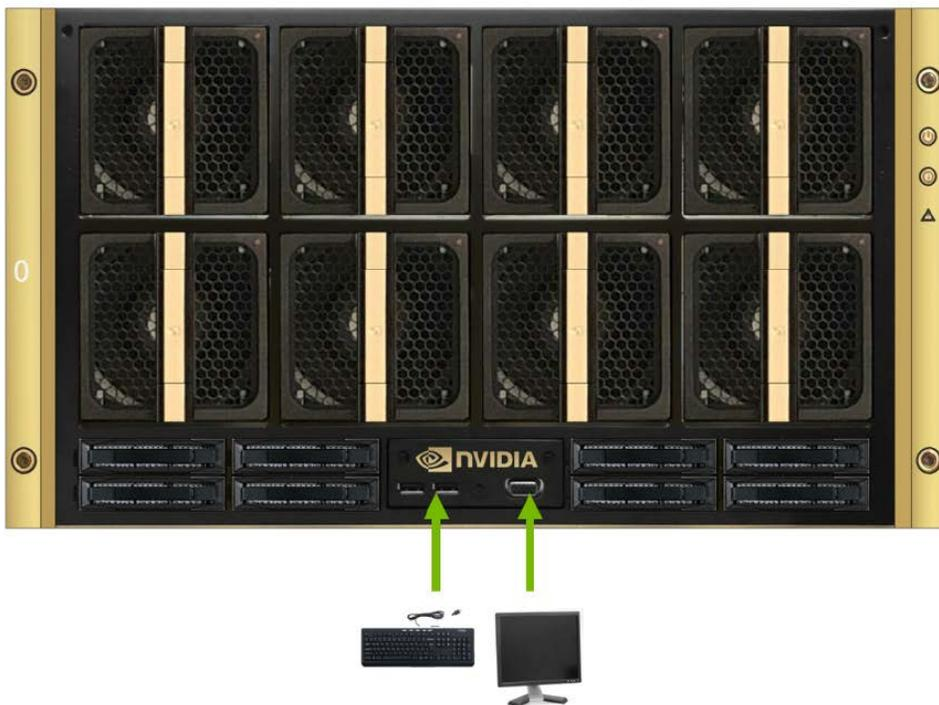

DGX A100 Server Rear

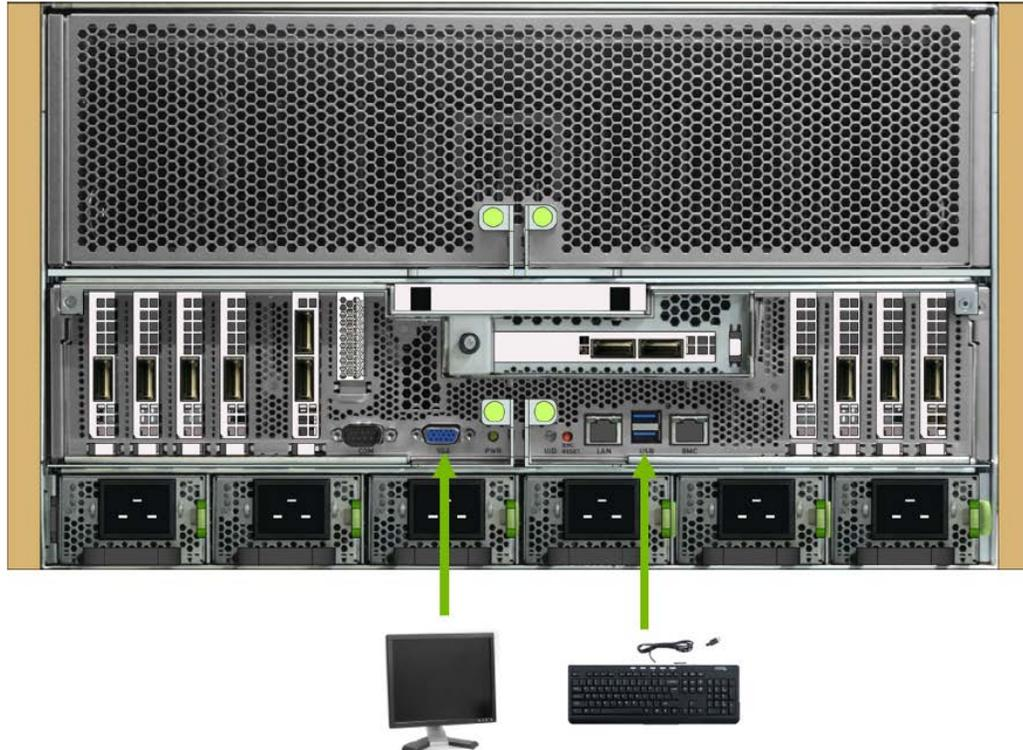

2.1.2. Remote Connection through the BMC

Here is some information about how you can remotely connect to DGX A100 through the BMC.



Note: CBMC Security

NVIDIA recommends that customers follow best security practices for BMC management (IPMI port). These include, but are not limited to, such measures as:

- ▶ Restricting the DGX A100 IPMI port to an isolated, dedicated management network.
- ▶ Using a separate, firewalled subnet.
- ▶ Configuring a separate VLAN for BMC traffic if a dedicated network is not available.

See [Configuring Static IP Address for the BMC](#) if you need to configure a static IP address for the BMC.

This method requires that you have the BMC login credentials. These credentials depend on the following conditions:

Before the First Boot Setup

- ▶ The default credentials are:

- ▶ Username: **admin**
- ▶ Password: **dgx1una.admin**



CAUTION: When you create a BMC admin user, we strongly recommend that you change the default password for this user. Do not use the default password.

After the First Boot Setup

During the first-boot procedure, you were prompted to configure an administrator username and password and a password for the BMC. The BMC username is the same as the administrator username:

- ▶ Username: **<administrator-username>**
- ▶ Password: **<bmc-password>**

1. Make sure you have connected the BMC port on the DGX A100 system to your LAN.
2. Open a browser within your LAN and go to <https://%3cbmc-ip-address%3E/>.
3. Make sure popups are allowed for the BMC address.
4. Log in.

The screenshot displays the NVIDIA DGX A100 BMC web interface. The top left shows system information: Mar 24 2020 12:54:54 CST, FW: 0.11.04, IP: 10.33.252.130, BMC: SCPP35.010DF1.8, Chassis Part: 920.23687.2539-090, Chassis SN: 157032000067, Host Online, and Chassis Identify LED. The dashboard includes four main widgets: Power On Hours (41 d 21 hrs), Pending Disassertions (281), Access Logs (23), and GPU Infa (8). Below these is a table for Firmware:

Firmware	BMC	BIOS	MB FPGA	MID FPGA	GB FPGA	PSU 0	PSU 1	PSU 2	PSU 3	PSU 4	PSU 5
Primary	0.11.04*	0.18	0.00.09	0.00.09	2.05	1.05	1.05	1.05	1.05	1.05	1.05
Secondary	0.00.00	0.15*	N/A	N/A	N/A	1.05	1.05	1.05	1.05	1.05	1.05
Communication	N/A	N/A	N/A	N/A	N/A	1.05	1.05	1.05	1.05	1.05	1.05

The interface also shows Front View and Rear View images of the system, and a Sensor Monitoring status indicating 'All sensors are good now!' and 'Currently recovered'.

5. From the left-side navigation menu, click Remote Control.

The Remote Control page allows you to open a virtual Keyboard/Video/Mouse (KVM) on the DGX A100 system, as if you were using a physical monitor and keyboard connected to the front of the system.

6. Click Launch KVM.

The DGX A100 console appears in your browser.

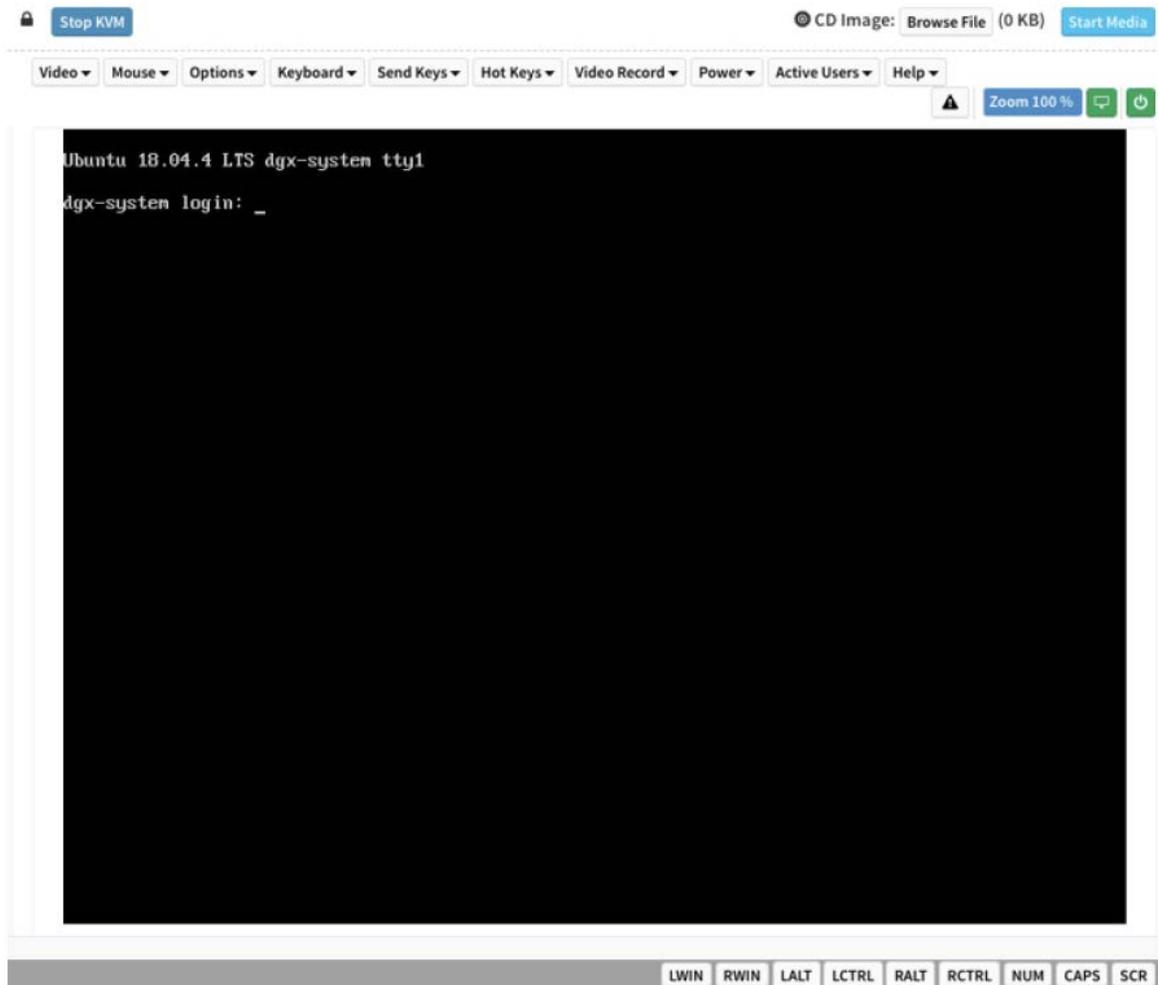

2.2. SSH Connection to the OS

Here is some information about how you can connect to the OS by using SSH.

After the system has been configured, you can also establish an SSH connection to the DGX A100 OS through the network port. Refer to [Network Ports](#) to identify the port to use and [Configuring Static IP Addresses for the Network Ports](#) to configure a static IP address.

Chapter 3. First Boot Setup

This section provides information about the set up process after you first boot the DGX A100 system.

While NVIDIA partner network personnel or NVIDIA field service engineers will install the DGX A100 system at the site and perform the first boot setup, the first boot setup instructions are provided here for reference and to support any reimaging of the server.

3.1. Setting up the System

These instructions describe the setup process that occurs the first time the DGX A100 system is powered on after delivery or after the server is re-imaged.

Be prepared to accept all End User License Agreements (EULAs) and to set up your username and password. To preview the EULA, visit <https://www.nvidia.com/en-us/data-center/dgx-systems/support/> and click the DGX EULA link.

1. Connect to the DGX A100 console as explained in “Connecting to the Console”.
2. To power on the DGX A100 system in one of the following ways:
 - ▶ Using the physical power button.



► Using the Remote BMC

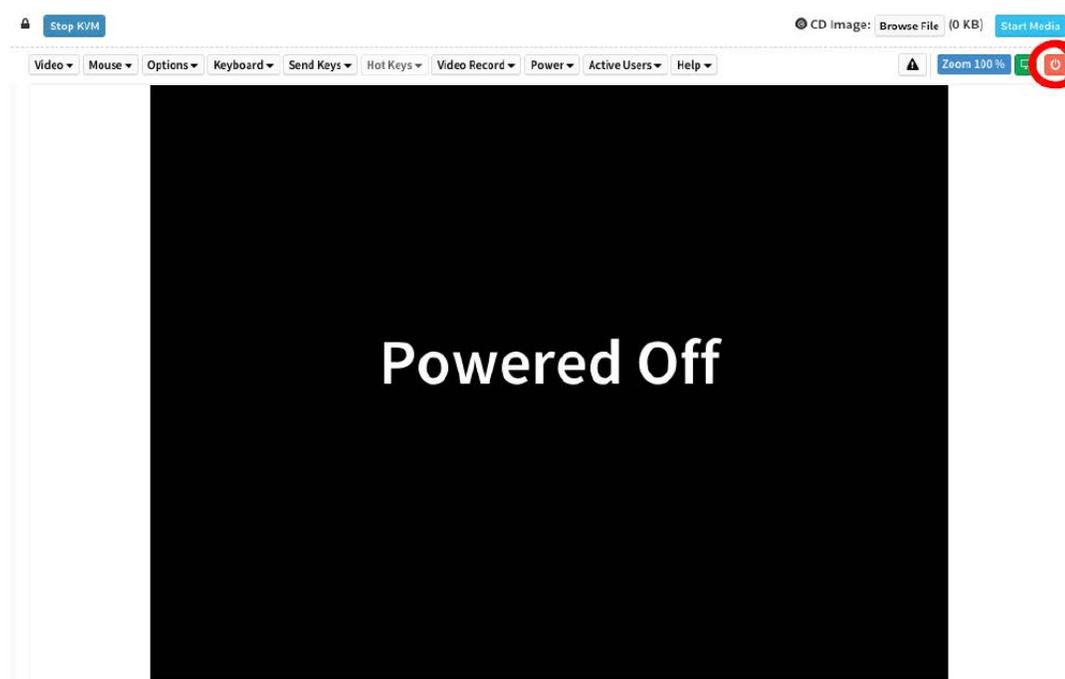

3. If the DGX OS was installed with an encrypted root filesystem, you will be prompted to unlock the drive.
4. Enter "nvidia3d" at the crypt: prompt.
5. You are presented with end user license agreements (EULAs) for the NVIDIA software.
6. Accept the EULA to proceed with the installation.

7. Perform the steps to configure the DGX A100 software.

- a). Select your language and locale preferences.
- b). Select the country for your keyboard.
- c). Select your time zone.
- d). Confirm the UTC clock setting.
- e). Create an administrative user account with your name, username, and password.

The administrator username is used also for the BMC login username and GRUB username.



Note: The BMC software will not accept "sysadmin" for a username. If you create this username for the system log in, "sysadmin" will not be available for logging in to the BMC.

- f). Create a BMC admin password.

The BMC password length must be a minimum of 13 and a maximum of 20 characters.



CAUTION: Once you create your login credentials, the default admin/dgxluna.admin credentials will no longer work.

- g). (Available starting with DGX OS 5.0) Create a GRUB password.

- ▶ Your GRUB password must have at least 8 characters.
If it has less than 8 characters, you will not be able to continue.
- ▶ You can select OK without entering a password which will disable this step, but NVIDIA recommends setting the GRUB password for security hardening.

- h). (Available starting with DGX OS 5.0) Create a root filesystem passphrase.

You will need the new passphrase to unlock the root filesystem when the system boots.

This step appears only if you installed the system with an encrypted root filesystem during DGX OS installation.

- i). Choose a primary network interface for the DGX A100 system; for example, `enp226s0`.

This should typically be the interface that you will use for subsequent system configuration or in-band management. Do not select `enp37s0f3u1u3c2` (or `bmc_redfish0` or similar), as this is intended only for out-of-band management or future support of in-band tools accessing the Redfish APIs.

After you select the primary network interface, the system attempts to configure the interface for DHCP and then asks you to enter the name server addresses.

- ▶ If no DHCP is available, then click OK at the Network autoconfiguration failed dialog and configure the network manually.
- ▶ If you want to configure a static address, then click Cancel at the dialog after the DHCP configuration completes to restart the network configuration steps.

- ▶ If you need to select a different network interface, then click Cancel at the dialog after the DHCP configuration completes to restart the network configuration steps.
 - j). If prompted, fill in requested networking information, such as name server or domain name.
 - k). Choose a host name for the DGX A100 system.
- After completing the setup process, the DGX A100 system reboots automatically and then presents the login prompt.

3.2. Post Setup Tasks

This section explains recommended tasks to perform after the initial system first-boot setup.



Note: RAID 1 Rebuild May Temporarily Affect System Performance. When the system is booted after restoring the image and running the first-boot setup, software RAID begins the process of rebuilding the RAID 1 array, which creates a mirror of (or resynchronizing) the drive containing the software. System performance may be affected during the RAID 1 rebuild process, which can take an hour to complete.

During this time, the command `nvsm show health` command will report a warning that the RAID volume is re-syncing.

You can check the status of the RAID 1 rebuild process using `sudo nvsm show volumes`, and then inspecting the output under `/systems/localhost/storage/ volumes/md0/rebuild`.

3.2.1. Obtaining Software Updates

To ensure you are running the latest version, you might need to update the software. Updating the software ensures your DGX A100 system contains important updates, including security updates. The Ubuntu Security Notice site (<https://usn.ubuntu.com/>) lists known Common Vulnerabilities and Exposures (CVEs), including those that can be resolved by updating the DGX OS software.

1. Run the package manager.

```
$ sudo apt update
```

2. Upgrade to the latest version.

```
$ sudo apt full-upgrade
```

3.2.2. Enabling the srp Daemon

The `srp_daemon` comes with the Mellanox drivers and is disabled by default. It is needed only if you are using RDMA over Infiniband (see SRP - SCSI RDMA Protocol). If necessary, you can enable the `srp_daemon` by issuing the following commands:

```
$ sudo systemctl enable srp_daemon.service
$ sudo systemctl enable srptools.service
```

Chapter 4. Quick Start and Basic Operation

This chapter provides basic requirements and instructions for using the DGX A100 system, including how to perform a preliminary health check and how to prepare for running containers. Go to the [DGX documentation](#) for additional product documentation.

4.1. Installation and Configuration

Before you install DGX A100, ensure you have given all relevant site information to your Installation Partner.



Important: Your DGX A100 System must be installed by NVIDIA partner network personnel or NVIDIA field service engineers. If not performed accordingly, your DGX A100 hardware warranty will be voided.

4.2. Registering Your DGX A100

To obtain support for your DGX A100, follow the instructions for registration in the Entitlement Certification email that was sent as part of the purchase.

Registration allows you to access the NVIDIA Enterprise Support Portal, obtain technical support, get software updates, and set up an NGC for DGX systems account. If you did not receive the information, open a case with the NVIDIA Enterprise Support Team at <https://www.nvidia.com/en-us/support/enterprise/>.

To obtain support for your DGX A100 system, follow the instructions for registration in the Entitlement Certification email that was sent as part of the purchase.

Registration allows you to access the NVIDIA Enterprise Support Portal, obtain technical support, get software updates, and set up an NGC for DGX systems account. If you did not receive the information, open a case with the NVIDIA Enterprise Support Team at <https://www.nvidia.com/en-us/support/enterprise/>.

Refer to the [Customer Support](#) chapter for customer support contact information.

4.3. Obtaining an NGC Account

Here is some information about how you can obtain an NGC account.

NVIDIA NGC provides simple access to GPU-optimized software for deep learning, machine learning, and high-performance computing (HPC). An NGC account grants you access to these tools and gives you the ability to set up a private registry to manage your customized software.

If you are the organization administrator for your DGX system purchase, work with NVIDIA Enterprise Support to set up an NGC enterprise account. Refer to the [NGC Private Registry User Guide](#) for more information about getting an NGC enterprise account.

4.4. Turning DGX A100 On and Off

DGX A100 is a complex system, integrating a large number of cutting-edge components with specific startup and shutdown sequences. Observe the following startup and shutdown instructions.

4.4.1. Startup Considerations

To keep your DGX A100 running smoothly, allow up to a minute of idle time after reaching the login prompt. This ensures that all components can complete their initialization.

4.4.2. Shutdown Considerations

When shutting down DGX A100, always initiate the shutdown from the operating system, momentary press of the power button, or by using Graceful Shutdown from the BMC, and wait until the system enters a powered-off state before performing any maintenance.



WARNING: Risk of Danger - Removing power cables or using Power Distribution Units (PDUs) to shut off the system while the Operating System is running may cause damage to sensitive components in the DGX A100 server.

4.5. Verifying Functionality - Quick Health Check

NVIDIA provides customers a diagnostics and management tool called NVIDIA System Management, or NVSM. The `nvs` command can be used to determine the system's health, identify component issues and alerts, or run a stress test to make sure all

components are in working order while under load. The use of Docker is key to getting the most performance out of the system since NVIDIA has optimized containers for all the major frameworks and workloads used on DGX systems.

The following are the steps for performing a health check on the DGX A100 System, and verifying the Docker and NVIDIA driver installation.

1. Establish an SSH connection to the DGX A100 System.
2. Run a basic system check.

```
$ sudo nvsm show health
```

3. Verify that the output summary shows that all checks are Healthy and that the overall system status is Healthy.
4. Verify that Docker is installed by viewing the installed Docker version.

```
$ sudo docker --version
```

This should return the version as “Docker version 19.03.5-ce”, where the actual version may differ depending on the specific release of the DGX OS Server software.

5. Verify connection to the NVIDIA repository and that the NVIDIA Driver is installed.

```
$ sudo docker run --gpus all --rm nvcr.io/nvidia/cuda:11.0-base nvidia-smi
```

Docker pulls the nvidia/cuda container image layer by layer, then runs nvidia-smi.

When completed, the output should show the NVIDIA Driver version and a description of each installed GPU.

See the NVIDIA Containers and Deep Learning Frameworks User Guide at <https://docs.nvidia.com/deeplearning/dgx/user-guide/index.html> for additional instructions, including an example of logging into the NGC container registry and launching a deep learning container.

4.6. Running the Pre-flight Test

Instructions for running the DGX stress test.

NVIDIA recommends running the pre-flight stress test before putting a system into a production environment or after servicing. You can specify running the test on the GPUs, CPU, memory, and storage, and also specify the duration of the tests.

To run the tests, use NVSM.

Syntax:

```
$ sudo nvsm stress-test [--usage] [--force] [--no-prompt] [<test>...] [DURATION]
```

For help on running the test, issue the following.

```
~$ sudo nvsm stress-test --usage
```

Recommended Command

The following command runs the test on all supported components (GPU, CPU, memory, and storage), and takes approximately 20 minutes.

```
~$ sudo nvsm stress-test --force
```

4.7. Running NGC Containers with GPU Support

To obtain the best performance when running NGC containers on DGX A100 systems, the following methods of providing GPU support for Docker containers are available:

- ▶ Native GPU support (included in Docker 19.03 and later)
- ▶ NVIDIA Container Runtime for Docker (nvidia-docker2 package)

The method implemented in your system depends on the DGX OS version installed.

DGX OS Releases	Method Included
5.0	<ul style="list-style-type: none"> ▶ Native GPU support ▶ NVIDIA Container Runtime for Docker (deprecated - availability to be removed in a future DGX OS release)

Each method is invoked by using specific Docker commands, described as follows.

4.7.1. Using Native GPU Support

Here is some information about using native GPU support.

Use `docker run --gpus` to run GPU-enabled containers.

- ▶ Example using all GPUs

```
$ sudo docker run --gpus all ...
```

- ▶ Example using two GPUs

```
$ sudo docker run --gpus 2 ...
```

- ▶ Examples using specific GPUs

```
$ sudo docker run --gpus '"device=1,2"' ...
$ sudo docker run --gpus '"device=UUID-ABCDEF,1"' ...
```

4.7.2. Using the NVIDIA Container Runtime for Docker

Currently, the DGX OS also includes the NVIDIA Container Runtime for Docker (nvidia-docker2) which lets you run GPU-accelerated containers in one of the following ways.

- ▶ Use `docker run` and specify `runtime=nvidia`.

```
$ docker run --runtime=nvidia ...
```

- ▶ Use `nvidia-docker run`.

```
$ nvidia-docker run ...
```

The `nvidia-docker2` package provides backward compatibility with the previous `nvidia-docker` package, so you can run GPU-accelerated containers using this command and the new runtime will be used.

- Use `docker run` with `nvidia` as the default runtime.

You can set `nvidia` as the default runtime, for example, by adding the following line to the `/etc/docker/daemon.json` configuration file as the first entry.

```
"default-runtime": "nvidia",
```

Here is an example of how the added line appears in the JSON file. Do not remove any pre-existing content when making this change.

```
{
  "default-runtime": "nvidia",
  "runtimes": {
    "nvidia": {
      "path": "/usr/bin/nvidia-container-runtime",
      "runtimeArgs": []
    }
  }
}
```

You can then use `docker run` to run GPU-accelerated containers.

```
$ docker run ...
```



CAUTION: If you build Docker images while `nvidia` is set as the default runtime, make sure the build scripts executed by the Dockerfile specify the GPU architectures that the container will need. Failure to do so might result in the container being optimized only for the GPU architecture on which it was built.

Instructions for specifying the GPU architecture depend on the application and are beyond the scope of this document. Consult the specific application build process.

4.8. Managing CPU Mitigations

includes security updates to mitigate CPU speculative side-channel vulnerabilities. These mitigations can decrease the performance of deep learning and machine learning workloads.

If your installation of DGX systems incorporates other measures to mitigate these vulnerabilities, such as measures at the cluster level, you can disable the CPU mitigations for individual DGX nodes and thereby increase performance. This capability is available starting with .

4.8.1. Determining the CPU Mitigation State of the DGX System

If you do not know whether CPU mitigations are enabled or disabled, issue the following.

```
$ cat /sys/devices/system/cpu/vulnerabilities/*
```

- CPU mitigations are enabled if the output consists of multiple lines prefixed with `Mitigation:`.

Example

```
KVM: Mitigation: Split huge pages
Mitigation: PTE Inversion; VMX: conditional cache flushes, SMT vulnerable
```

```
Mitigation: Clear CPU buffers; SMT vulnerable
Mitigation: PTI
Mitigation: Speculative Store Bypass disabled via prctl and seccomp
Mitigation: usercopy/swapgs barriers and __user pointer sanitization
Mitigation: Full generic retpoline, IBPB: conditional, IBRS_FW, STIBP:
conditional, RSB filling
Mitigation: Clear CPU buffers; SMT vulnerable
```

- ▶ CPU mitigations are disabled if the output consists of multiple lines prefixed with Vulnerable.

Example

```
KVM: Vulnerable
Mitigation: PTE Inversion; VMX: vulnerable
Vulnerable; SMT vulnerable
Vulnerable
Vulnerable
Vulnerable: __user pointer sanitization and usercopy barriers only; no swapgs
barriers
Vulnerable, IBPB: disabled, STIBP: disabled
Vulnerable
```

4.8.2. Disabling CPU Mitigations



CAUTION: Performing the following instructions will disable the CPU mitigations provided by the DGX OS Server software.

1. Install the `nv-mitigations-off` package.

```
$ sudo apt install nv-mitigations-off -y
```

2. Reboot the system.

3. Verify CPU mitigations are disabled.

```
$ cat /sys/devices/system/cpu/vulnerabilities/*
```

The output should include several `Vulnerable` lines. See [Determining the CPU Mitigation State of the DGX System](#) for example output.

4.8.3. Re-enabling CPU Mitigations

1. Remove the `nv-mitigations-off` package.

```
$ sudo apt purge nv-mitigations-off
```

2. Reboot the system.

3. Verify CPU mitigations are enabled.

```
$ cat /sys/devices/system/cpu/vulnerabilities/*
```

The output should include several `Mitigations` lines. See [Determining the CPU Mitigation State of the DGX System](#) for example output.

Chapter 5. Additional Features and Instructions

This chapter describes specific features of the DGX A100 server to consider during setup and operation.

5.1. Managing the DGX Crash Dump Feature

The DGX OS includes a script to manage this feature.

5.1.1. Using the Script

This section provides information about how to use the script to manage DGX crash dumps.

- ▶ To enable only dmesg crash dumps, enter the following command:

```
$ /usr/sbin/dgx-kdump-config enable-dmesg-dump
```

This option reserves memory for the crash kernel.

- ▶ To enable both dmesg and vmcore crash dumps, enter the following command:

```
$ /usr/sbin/dgx-kdump-config enable-vmcore-dump
```

This option reserves memory for the crash kernel.

- ▶ To disable crash dumps, enter the following:

```
$ /usr/sbin/dgx-kdump-config disable
```

This option disables the use of kdump and make sure no memory is reserved for the crash kernel.

5.1.2. Connecting to Serial Over LAN to View the Console

While dumping vmcore, the BMC screen console goes blank approximately 11 minutes after the crash dump is started. To view the console output during the crash dump, connect to serial over LAN as follows:

```
$ ipmitool -I lanplus -H <bmc-ip-address> -U <BMC-USERNAME> -P <BMC-PASSWORD>
```

```
sol activate
```

Chapter 6. Managing the DGX A100 Self-Encrypting Drives

The NVIDIA DGX OS software supports the ability to manage self-encrypting drives (SEDs), including setting an Authentication Key for locking and unlocking the drives on NVIDIA DGX™ A100 systems. You can manage only the SED data drives.

The software cannot be used to manage OS drives even if they are SED-capable.

6.1. Overview

The SED management software is in the `nv-disk-encrypt` package.

The software supports the following configurations:

- ▶ NVIDIA DGX A100 systems where all data drives are self-encrypting drives.
- ▶ Only SEDs used as data drives are supported.
The software will not manage SEDs that are OS drives.

The software provides the following functionality:

- ▶ Identifies eligible drives on the system.
- ▶ Allows you to you assign Authentication Keys (passwords) for each SED as part of the initialization process.
 - ▶ Alternatively, the software can generate random passwords for each drive.
 - ▶ The passwords are stored in a password-protected vault on the system.
- ▶ Once initialized, SEDs are locked upon power loss, such as a system shutdown or drive removal.
Locked drives get unlocked after power is restored and the root file system is mounted.
- ▶ Provides functionality to export the vault.
- ▶ Provides functionality for erasing the drives.
- ▶ Provides the ability to revert the initialization.

6.2. Installing the Software

Use the package manager to install the `nv-disk-encrypt` package and, optionally, the TPM2 tools package, and reboot the system. You need the TPM tools package if you plan to use the TPM2 to store security keys.

1. Update the packages.

```
$ sudo apt update
```

2. Install `nv-disk-encrypt`.

```
$ sudo apt install -y nv-disk-encrypt
```

3. (Optional) Install `tpm2-tools`.

```
$ sudo apt install -y tpm2-tools
```

4. Reboot.

```
$ sudo reboot
```

If you plan to use TPM2, enable it. Refer to “Configuring Trusted Computing” for more information.

6.3. Configuring Trusted Computing

Here is some information about the controls that are required to configure Trusted Computing (TC).

The DGX A100 system BIOS provides setup controls for configuring the following TC features:

- ▶ Trusted Platform Module

The NVIDIA DGX A100 incorporates Trusted Platform Module 2.0 (TPM 2.0) which can be enabled from the system BIOS and used in conjunction with the `nv-disk-encrypt` tool. After being enabled, the `nv-disk-encrypt` tool uses the TPM for encryption and stores the vault and SED authentication keys on the TPM instead of on the file system. Using the TPM is preferred because this allows the vault data to persist even if the system is reimaged.

- ▶ Block SID

Certain drives shipped with the DGX A100 system might support the Block SID authentication feature. Block SID authentication prevents malicious actors from taking ownership of drives and blocks others from using the drives. By default, the DGX BIOS will send the Block SID request. On such setups, you will need to enable the Disable Block Sid feature in the BIOS before proceeding with the initialization steps.

6.3.1. Determining Whether Drives Support SID

The drive model is a good indicator of whether the drive supports this feature. Issue the following and look for the `KCM6DRUL3T84` model string:

```
$ sudo nvme list
Node          SN          Model ...
-----
/dev/nvme0n1 70H0A0AHTTHR KCM6DRUL3T84 ...
/dev/nvme1n1 70H0A007TTHR KCM6DRUL3T84
```

6.3.2. Enabling the TPM and Preventing the BIOS from Sending Block SID Requests

This section provides instructions to enable the TPM and prevent the SBIOS from sending Block SID request. Each task is independent, so you can select which task to complete.

1. Reboot the DGX A100, then press [Del] or [F2] at the NVIDIA splash screen to enter the BIOS Setup.
2. Navigate to the Advanced tab on the top menu, then scroll to Trusted Computing and press [Enter].
 - ▶ To enable TPM, scroll to Security Device and switch the setting to Enabled.
 - ▶ To disable Block SID, scroll to Disable Block Sid, then switch to Enabled.
3. Save and exit the BIOS Setup to continue the boot process.

If you disabled Block SID, you will be prompted to accept the request to disable issuing a Block SID Authentication command.



4. Press F10 at the prompt.
After the system boots, you can proceed to initialize drive encryption.

6.4. Initializing the System for Drive Encryption

Here is some information about how to initialize the system for drive encryption.



Note: Before initializing drive encryption, review the information in [Configuring Trusted Computing](#) and follow the configuration instructions if needed.

Initialize the system for drive encryption using the `nv-disk-encrypt` command.

```
$ sudo nv-disk-encrypt init [-k <your-vault-password>] [-f <path/to/json-file>] [-g]
[-r]
```

Here is a list of the options:

- ▶ `-k`: Lets you create the vault password in the command.
Otherwise, the software will prompt you to create a password before proceeding.
- ▶ `-f`: Lets you specify a JSON file that contains a mapping of passwords to drives.
Refer to “Example 1: Passing in the JSON File” for further instructions.
- ▶ `-g`: Generates random salt values (stored in `/etc/nv-disk-encrypt/.dgxenc.salt`) for each drive password.

Salt values are characters added to a password for enhanced password security. NVIDIA strongly recommends using this option for best security, otherwise the software will use a default salt value instead of a randomly generated one.
- ▶ `-r`: Generates random passwords for each drive.

This avoids the need to create a JSON file or the need to enter a password one by one during the initialization.

6.5. Enabling Drive Locking

After initializing the system for SED management, issue the following command, which uses the `nv-disk-encrypt` command to enable drive locking.

```
$ sudo nv-disk-encrypt lock
```

After initializing the system and enabling drive locking, the drives will become locked when they lose power. The system will automatically unlock each drive when power is restored to the system and the system is rebooted.

6.6. Initialization Examples

This section provides some initialization examples.

6.6.1. Example 1: Passing in the JSON File

The following instructions in this section describe a method to specify the drive/password mapping ahead of time. This method is useful for initializing several drives at a time and avoids the need to enter the password for each drive after issuing the initialization command, or if you want control of the passwords.

Refer to the following for more information:

- ▶ [Determining Which Drives Can be Managed as Self-Encrypting](#)
- ▶ [Creating the Drive/Password Mapping JSON Files and Using it to Initialize the System](#)

6.6.1.1. Determining Which Drives Can be Managed as Self-Encrypting

Here is some information about how you can determine which drives can be managed as self-encrypting.

Review the storage layout of the DGX system to determine which drives are eligible to be managed as SEDs.

```
$ sudo nv-disk-encrypt info
```

The default output shows which drives can be used for encryption and which drives cannot. The following status information is provided:

- ▶ SED capable: Is this a self-encrypting drive?
- ▶ Boot disk: Is this drive currently being used as a boot drive? Does it contain the root filesystem?
- ▶ Locked: Is this drive currently in the locked state? Is it able to accept I/O?. It can only be in this state after the following conditions have been met:
 - ▶ Locking has been enabled (nv-disk-encrypt init, followed by nv-disk-encrypt init lock)
 - ▶ The drive is coming back from power-off.
 - ▶ The user queries this state prior to it being (automatically) unlocked.
- ▶ Lock Enabled: Are locks enabled on this drive? It will be in this state after initialization (nv-disk-encrypt init).
- ▶ MBR done: This setting is only relevant for drives that support MBR shadowing. On drives that support this feature, this will report 'Y' after initialization (nv-disk-encrypt init)

MBR done: This setting is only relevant for drives that support MBR shadowing. On drives that support this feature, this will report 'Y' after initialization (nv-disk-encrypt init)

The following example output snippet shows drives that can be used for encryption. Notice SED capable = Y and Boot disk = N.

```

+-----+
|·Name·|·Serial·|·Status·|
+-----+
|·/dev/nvme3n1·|·xxxxx1·|·SED·capable·:=·Y,·Boot·disk·:=·N,·Locked·:=·N,·Lock·Enabled·:=·N,·MBR·done·:=·N·|
|·/dev/nvme6n1·|·xxxxx2·|·SED·capable·:=·Y,·Boot·disk·:=·N,·Locked·:=·N,·Lock·Enabled·:=·N,·MBR·done·:=·N·|
|·/dev/nvme9n1·|·xxxxx3·|·SED·capable·:=·Y,·Boot·disk·:=·N,·Locked·:=·N,·Lock·Enabled·:=·N,·MBR·done·:=·N·|

```

The following example output snippet shows drives that cannot be used for encryption. Notice SED capable = Y and Boot disk = Y, or SED capable = N.

```

+-----+
|·Name·|·Serial·|·Status·|
+-----+
|·/dev/nvme0n1·|·xxxxx1·|·SED·capable·:=·Y,·Boot·disk·:=·Y,·Locked·:=·N,·Lock·Enabled·:=·N,·MBR·done·:=·N·|
|·/dev/sr0·|·xxxxx2·|·SED·capable·:=·N,·Boot·disk·:=·N,·Locked·:=·N,·Lock·Enabled·:=·N,·MBR·done·:=·N·|
|·/dev/nvme1n1·|·xxxxx3·|·SED·capable·:=·Y,·Boot·disk·:=·Y,·Locked·:=·N,·Lock·Enabled·:=·N,·MBR·done·:=·N·|
|·/dev/sda·|·unknown·|·SED·capable·:=·N,·Boot·disk·:=·N,·Locked·:=·N,·Lock·Enabled·:=·N,·MBR·done·:=·N·|

```

Alternatively, you can specify the output be presented in JSON format by using the `-j` option.

```
$ sudo nv-disk-encrypt info -j
```

In this case, drives that can be used for encryption are indicated by the following:

```
"sed_capable": true "used_for_boot": false
```

And drives that cannot be used for encryption are indicated by one of the following:

```
"sed_capable": true "used_for_boot": true
```

Or

```
"sed_capable": false
```

6.6.1.2. Creating the Drive/Password Mapping JSON Files and Using it to Initialize the System

You can initialize the system by creating the drive and password map the JSON files.

1. Create a JSON file that lists all the eligible SED-capable drives that you want to manage.



Note: These are the list of drives that you obtained from [Determining Which Drives Can be Managed as Self-Encrypting](#).

The following example shows the format of the JSON file.

```
{
"/dev/nvme2n1": "<your-password>",
"/dev/nvme3n1": "<your-password>",
"/dev/nvme4n1": "<your-password>",
"/dev/nvme5n1": "<your-password>",
}
```

- ▶ Ensure that you follow the syntax exactly.
 - ▶ Passwords must consist of only upper-case letters, lower-case letters, digits, and/or the following special characters: `~ : @ % ^ + = _`,
2. Initialize the system and then enable locking.

The following command assumes you have placed the JSON file in the /tmp directory.

```
$ sudo nv-disk-encrypt init -f /tmp/<your-file>.json -g
$ sudo nv-disk-encrypt lock
```

When prompted, enter a password for the vault.

Passwords must consist of only upper-case letters, lower-case letters, digits, and/or the following special characters: ~ : @ % ^ + = _ ,

6.6.2. Example 2: Generating Random Passwords

The commands in this topic use the `-k` and `-r` options so that you are not prompted to enter passwords. You pass the vault password into the command and then the command instructs the tool to generate random passwords for each drive.

The vault password must consist of only upper-case letters, lower-case letters, digits, and/or the following special-characters: ~ : @ % ^ + = _ ,

```
$ sudo nv-disk-encrypt init -k <your-vault-password> -g -r
$ sudo nv-disk-encrypt lock
```

6.6.3. Example 3: Specifying Passwords One at a Time When Prompted

If there are a small number of drives, or you do not want to create a JSON file, issue the following command.

```
$ sudo nv-disk-encrypt init -g
$ sudo nv-disk-encrypt lock
```

The software prompts you to enter a password for the vault and then a password for each eligible SED.

Passwords must consist of only upper-case letters, lower-case letters, digits, and/or the following special characters: ~ : @ % ^ + = _ ,

6.7. Disabling Drive Locking

To disable drive locking at any time after you initialize, run the following command: `$ sudo nv-disk-encrypt disable`

This command disables locking on all drives. You can run the initial set up again at any time after this process is complete.

6.8. Enabling Drive Locking

After initializing the system for SED management, issue the following command, which uses the `nv-disk-encrypt` command to enable drive locking.

```
$ sudo nv-disk-encrypt lock
```

After initializing the system and enabling drive locking, the drives will become locked when they lose power. The system will automatically unlock each drive when power is restored to the system and the system is rebooted.

6.9. Exporting the Vault

Here is some information about how to export the vault.

To export all drive keys out to a file, use the export function. This requires that you pass in the vault password.

```
$ sudo nv-disk-encrypt export -k yourvaultpassword
Writing vault data to /tmp/secrets.out
```

6.10. Erasing Your Data

Here is some information about how you can erase your data.



WARNING: Be aware when executing this that all data will be lost. On DGX A100 systems, these drives generally form a RAID 0 array, and this array will also be destroyed when you perform an erase.

After initializing the system for SED management, use the `nv-disk-encrypt` command to erase data on your drives after stopping `cachefilesd` and unmounting the RAID array as follows.

1. Completely stop the RAID.

```
$ systemctl stop cachefilesd
$ sudo umount /raid
$ sudo mdadm --stop /dev/md1
```

2. Perform the erase.

```
$ sudo nv-disk-encrypt erase
```

This command does the following:

- ▶ Sets the drives in an unlocked state.
- ▶ Disables locking on the drives.
- ▶ Removes the RAID 0 array configuration.

To rebuild the RAID array, issue the following command:

```
$ sudo /usr/bin/configure_raid_array.py -c -f
```

6.11. Clearing the TPM

If you've lost the password to your TPM, you will not be able to access its contents. In this case, the only way to regain access to the TPM is to clear the TPM's contents. After clearing the TPM, you will need to re-initialize the vault and SED authentication keys.

1. Reboot the DGX A100, then press [Del] or [F2] at the NVIDIA splash screen to enter the BIOS Setup.
2. Navigate to the Advanced tab on the top menu, scroll to Trusted Computing, and press [Enter].
3. Clear TPM2.
 - a). Scroll to Trusted Computing and press [Enter].
 - b). Scroll to Pending Operation and press [Enter].
 - c). Select TPM Clear at the Pending Operation popup and press [Enter].
4. Save and exit the BIOS Setup.

6.12. Changing Disk Passwords, Adding Disks, or Replacing Disks

The same steps are needed for changing or rotating passwords, adding disks, or replacing disks.

Context for the current task.

1. Disable SED management.

```
$ sudo nv-disk-encrypt disable
```
2. Add or replace drives as needed and then rebuild the RAID array.
Refer to the [NVIDIA DGX A100 Service Manual](#) for more information.
3. Enable SED management and assign passwords per the instructions in [Initializing the System for Drive Encryption](#).

6.13. Recovering From Lost Keys

NVIDIA recommends backing up your keys and storing them in a secure location. If you've lost the key used to initialize and lock your drives, you will not be able to unlock the drive again. If this happens, the only way to recover is to perform a factory-reset, which will result in a loss of data.

SED drives come with a PSID printed on the label; this value can only be obtained by physically examining the drive as exemplified in the following image.



Specify the PSID to reset the drive using the following sedutil-cli command:

Chapter 7. Network Configuration

This chapter describes key network considerations and instructions for the DGX A100 System.

7.1. Configuring Network Proxies

If your network requires use of a proxy server, you will need to set up configuration files to ensure the DGX A100 System communicates through the proxy.

7.1.1. For the OS and Most Applications

Edit the `/etc/environment` file and add the following proxy addresses to the file, below the `PATH` line.

```
http_proxy="http://<username>:<password>@<host>:<port>/"
ftp_proxy="ftp://<username>:<password>@<host>:<port>/"
https_proxy="https://<username>:<password>@<host>:<port>/"
no_proxy="localhost,127.0.0.1,localaddress,.localdomain.com"
HTTP_PROXY="http://<username>:<password>@<host>:<port>/"
FTP_PROXY="ftp://<username>:<password>@<host>:<port>/"
HTTPS_PROXY="https://<username>:<password>@<host>:<port>/"
NO_PROXY="localhost,127.0.0.1,localaddress,.localdomain.com"
```

Where username and password are optional.

```
http_proxy="http://myproxy.server.com:8080/"
ftp_proxy="ftp://myproxy.server.com:8080/"
https_proxy="https://myproxy.server.com:8080/";
```

7.1.2. For apt

Edit (or create) the `/etc/apt/apt.conf.d/myproxy` proxy file and include the following lines:

```
Acquire::http::proxy "http://<username>:<password>@<host>:<port>/"
Acquire::ftp::proxy "ftp://<username>:<password>@<host>:<port>/"
Acquire::https::proxy "https://<username>:<password>@<host>:<port>/"
```

Where username and password are optional.

Example:

```
Acquire::http::proxy "http://myproxy.server.com:8080/"
Acquire::ftp::proxy "ftp://myproxy.server.com:8080/"
Acquire::https::proxy "https://myproxy.server.com:8080/"
```

7.1.3. For Docker

To ensure that Docker can access the NGC container registry through a proxy, Docker uses environment variables. For best practice recommendations on configuring proxy environment variables for Docker, see <https://docs.docker.com/>.

7.2. Configuring Docker IP Addresses

To ensure that the DGX A100 system can access the network interfaces for Docker containers, Docker should be configured to use a subnet distinct from other network resources used by the DGX A100 System.

By default, Docker uses the 172.17.0.0/16 subnet. Consult your network administrator to find out which IP addresses are used by your network. If your network does not conflict with the default Docker IP address range, no changes are needed, and you can skip this section.

However, if your network uses the addresses within this range for the DGX A100 system, you should change the default Docker network addresses.

You can change the default Docker network addresses by modifying the `/etc/docker/daemon.json` file or modifying the `/etc/systemd/system/docker.service.d/docker-override.conf` file. These instructions provide an example of modifying the `/etc/systemd/system/docker.service.d/docker-override.conf` file to override the default Docker network addresses.

1. Open the `docker-override.conf` file for editing.

```
$ sudo vi /etc/systemd/system/docker.service.d/docker-override.conf
[Service] ExecStart=
ExecStart=/usr/bin/dockerd -H fd:// -s overlay2 LimitMEMLOCK=infinity
LimitSTACK=67108864
```

2. Make the changes indicated in bold below, setting the correct bridge IP address and IP address ranges for your network.

Consult your IT administrator for the correct addresses.

```
[Service] ExecStart=
ExecStart=/usr/bin/dockerd -H fd:// -s overlay2 --bip=192.168.127.1/24
--fixed-cidr=192.168.127.128/25
LimitMEMLOCK=infinity
LimitSTACK=67108864
```

3. When you are finished save and close the `/etc/systemd/system/docker.service.d/docker-override.conf` file.
4. Reload the `systemctl` daemon.

```
$ sudo systemctl daemon-reload
```

5. Restart Docker.

```
$ sudo systemctl restart docker
```

7.3. Open Ports

Make sure that the ports listed in the following table are open and available on your firewall to the DGX A100 System.

Table 7. Open Ports

Port (Protocol)	Direction	Use
22 (TCP)	Inbound	SSH
53 (UDP)	Outbound	DNS
80 (TCP)	Outbound	HTTP, package updates
443 (TCP)	Outbound	For internet (HTTP/HTTPS) connection to NVIDIA GPU Cloud If port 443 is proxied through a corporate firewall, then WebSocket protocol traffic must be supported.
443 (TCP)	Inbound	For BMC web services, remote console services, cd-media service, and Redfish. If port 443 is proxied through a corporate firewall, WebSocket protocol traffic must be supported.

7.4. Connectivity Requirements for NGC Containers

To run NVIDIA NGC containers from the NGC container registry, your network must be able to access the following URLs:

- ▶ <http://archive.ubuntu.com/ubuntu/>
- ▶ <http://security.ubuntu.com/ubuntu/>
- ▶ <http://international.download.nvidia.com/dgx/repos/>

This URL should be accessed by using `apt-get`, not through a browser.

- ▶ <https://apt.dockerproject.org/repo/>
- ▶ <https://download.docker.com/linux/ubuntu/>
- ▶ <https://nvcr.io/>

To verify connection to `nvcr.io`, run the following command:

```
$ wget https://nvcr.io/v2
```

You should see connecting verification followed by a 401 error.

```
--2018-08-01 19:42:58-- https://nvcr.io/v2
Resolving nvcr.io (nvcr.io)... 52.8.131.152, 52.9.8.8
Connecting to nvcr.io (nvcr.io)|52.8.131.152|:443... connected.
HTTP request sent, awaiting response... 401 Unauthorized
```

7.5. Configuring a Static IP Address for the BMC

This section explains how to set a static IP address for the BMC. You will need to do this if your network does not support DHCP.

Use one of the methods described in the following sections:

- ▶ [Configuring a BMC Static IP Address Using ipmitool](#)
- ▶ [Configuring a BMC Static IP Address Using the System BIOS](#)

7.5.1. Configuring a BMC Static Address by Using ipmitool

This section describes how to set a static IP address for the BMC from the Ubuntu command line.



Note: If you cannot access the DGX A100 System remotely, then connect a display (1440x900 or lower resolution) and keyboard directly to the DGX A100 system.

To view the current settings, enter the following command.

```
$ sudo ipmitool lan print 1
```

1. Set the IP address source to static.

```
$ sudo ipmitool lan set 1 ipsrc static
```

2. Set the appropriate address information.

- ▶ To set the IP address (“Station IP address” in the BIOS settings), enter the following and replace the italicized text with your information.

```
$ sudo ipmitool lan set 1 ipaddr <my-ip-address>
```

- ▶ To set the subnet mask, enter the following and replace the italicized text with your information.

```
$ sudo ipmitool lan set 1 netmask <my-netmask-address>
```

- ▶ To set the default gateway IP (“Router IP address” in the BIOS settings), enter the following and replace the italicized text with your information.

```
$ sudo ipmitool lan set 1 defgw ipaddr <my-default-gateway-ip-address>
```

7.5.2. Configuring a BMC Static IP Address by Using the System BIOS

This section describes how to set a static IP address for the BMC when you cannot access the DGX A100 System remotely, and this process involves setting the BMC IP address during system boot.

1. Connect a keyboard and display (1440 x 900 maximum resolution) to the DGX A100 System and turn on the DGX A100 System.
2. When you see the SBIOS version screen, press Del or F2 to enter the BIOS Setup Utility screen.
3. At the BIOS Setup Utility screen, navigate to the Server Mgmt tab on the top menu, then scroll to BMC network configuration and press Enter.
4. Scroll to Configuration Address Source and press Enter, then at the Configuration Address source pop-up, select Static and then press Enter.
5. Set the addresses for the Station IP address, Subnet mask, and Router IP address as needed by performing the following for each:
 - a). Scroll to the specific item and press Enter.
 - b). Enter the appropriate information at the pop-up, then press Enter.
6. When finished making all your changes, press F10 to save and exit.

7.6. Configuring a BMC Static IP Address for the Network Ports

During the initial boot setup process for the DGX A100 System, you had an opportunity to configure static IP addresses for a single network interface. If you did not set this up at that time, you can configure the static IP addresses from the Ubuntu command line using the following instructions.



Note: If you are connecting to the DGX A100 console remotely, connect using the BMC remote console. If you connect using SSH, your connection will be lost when performing the final step. Also, if you encounter issues with the config file, the BMC connection will facilitate troubleshooting.

If you cannot access the DGX A100 System remotely, then connect a display (1440x900 or lower resolution) and keyboard directly to the DGX A100 System.

1. Determine the port designation that you want to configure, based on the physical Ethernet port that you have connected to your network.
See [Configuring Network Proxies](#) for the port designation of the connection you want to configure.

2. Edit the network configuration yaml file.



Note: Ensure that your file is identical to the following sample with regard to spacing; please do not use tabs!

```
$ sudo vi /etc/netplan/01-netcfg.yaml

network:
  version: 2
  renderer: networkd
  ethernets:

    <port-designation>:
      dhcp4: no
      dhcp6: no
      addresses: [10.10.10.2/24]
      gateway4: 10.10.10.1
      nameservers:
        search: [<mydomain>, <other-domain>]
        addresses: [10.10.10.1, 1.1.1.1]
```

Consult your network administrator for the appropriate information for the items in bold, such as network, gateway, and nameserver addresses, and use the port designations that you determined in step 1.

3. After you complete your edits, press ESC to switch to command mode, then save the file to the disk and exit the editor.
4. Apply the changes.

```
$ sudo netplan apply
```



Note: If you are not returned to the command line prompt after a minute, reboot the system.

For additional information, see <https://help.ubuntu.com/lts/serverguide/network-configuration.html.en>.

7.7. Switching Between InfiniBand and Ethernet

The NVIDIA DGX A100 System is equipped with up to eight NVIDIA ConnectX-6 or ConnectX-7 single-port network cards on the I/O board, typically used for cluster communications. By default, these are configured as InfiniBand ports, but you have the option to convert these to Ethernet ports.

For these changes to work properly, the configured port must connect to a networking switch that matches the port configuration. In other words, if the port configuration is set to InfiniBand, then the external switch should be an InfiniBand switch with the corresponding InfiniBand cables. If the port configuration is set to Ethernet, the switch should also be Ethernet.

The DGX A100 is also equipped with one (and optionally two) dual-port connections typically used for network storage and configured by default for Ethernet. These can also be configured for InfiniBand.



Note: On the dual-port cards, if one of the ports is configured for Ethernet and the other port is configured for InfiniBand, the following limitations apply.

- ▶ FDR is not supported on the InfiniBand port (port 1 or 2).
- ▶ If port 1 is InfiniBand, then port 2 (Ethernet) does not support 40 GbE/10GbE.
- ▶ If port 1 is Ethernet, then port 2 (InfiniBand) does not support EDR.

7.7.1. Starting the Mellanox Software Tools and Determining the Current Port Configuration

Here is some information about how you can start the Mellanox software tools and determine the configuration for the current port.

Start the Mellanox Software Tools services.

```
$ sudo mst start
```

To determine the current port configuration, enter the following:

```
$ sudo mlxconfig -e query | egrep -e Device\\|LINK_TYPE
```

The following example shows the output for one of the port devices, showing the device path and the default, current, and next boot configuration.

```
Device #2:
Device type: ConnectX6
Device: /dev/mst/mt4123_pciconf8
Configurations: Default Current Next Boot
* LINK_TYPE_P1 IB(1) IB(1) IB(1)
```

- ▶ IB(1) indicates the port is configured for InfiniBand.
- ▶ ETH(2) indicates the port is configured for Ethernet.

Determine the Device path bus numbers for the slot number of the port you want to configure. Refer to the table in [Open Ports](#) for the mapping.

7.7.2. Switching the Port Configuration

Make sure that you have started the Mellanox Software Tools (MST) services as described in [Starting the Mellanox Software Tools and Determining the Current Port Configuration](#) and have identified the correct ports to change.

Issue `mlxconfig` for each port you want to configure.

```
$ sudo mlxconfig -y -d <device-path> set LINK_TYPE_P1=<config-number>
```

where:

- ▶ `<device-path>` corresponds to the port you want to configure.
- ▶ `<config-number>` is 1 for InfiniBand and 2 for Ethernet.

Here is an example to set slot 0 to Ethernet:

```
$ sudo mlxconfig -y -d /dev/mst/mt4123_pciconf2 set LINK_TYPE_P1=2
```

Here is an example that sets slot 1 to InfiniBand:

```
$ sudo mlxconfig -y -d /dev/mst/mt4123_pciconf3 set LINK_TYPE_P1=1
```

Chapter 8. Configuring Storage

By default, the DGX A100 System includes four SSDs in a RAID 0 configuration. These SSDs are intended for application caching, so you must set up your own NFS storage for long-term data storage. The instructions in this section describe how to mount the NFS on the DGX A100 System and how to cache the NFS using the DGX A100 SSDs for improved performance.

Disabling cachefilesd

The DGX A100 system uses cachefilesd to manage the caching of the NFS. To disable:

```
$ sudo systemctl stop cachefilesd
$ sudo systemctl disable cachefilesd
```

Using cachefilesd

The following instructions describe how to mount the NFS onto the DGX A100 system and how to cache the NFS using the DGX A100 SSDs for improved performance.

Make sure that you have an NFS server with one or more exports with data to be accessed by the DGX A100 System and that there is network access between the DGX A100 System and the NFS server.

1. Configure an NFS mount for the DGX A100 System.
 - a). Edit the filesystem tables configuration.

```
$ sudo vi /etc/fstab
```

- b). Add a new line for the NFS mount, using the local mount point of /mnt.

```
<nfs_server>:<export_path> /mnt nfs
rw,noatime,rsize=32768,wsize=32768,nolock,tcp,intr,fsc,nofail 0 0
```

- ▶ • /mnt is used here as an example mount point.
- ▶ • Consult your Network Administrator for the correct values for <nfs_server> and <export_path>.
- ▶ • The nfs arguments presented here are a list of recommended values based on typical use cases.

However, "fsc" must always be included as that argument specifies use of FS-Cache.

- c). Save the changes.

2. Verify the NFS server is reachable.

```
$ ping <nfs_server>
```

Use the server IP address or the server name provided by your network administrator.

3. Mount the NFS export.

```
$ sudo mount /mnt
/mnt is an example mount point.
```

4. Verify caching is enabled.

```
$ cat /proc/fs/nfsfs/volumes
```

In the output, look for `FSC=yes`.

The NFS will be automatically mounted and cached on the DGX A100 System in subsequent reboot cycles.

8.1. Setting Filesystem Quotas

When running NGC containers, you might need to limit the amount of disk space that is used on a filesystem to avoid filling up the partition. Refer to <https://www.digitalocean.com/community/tutorials/how-to-set-filesystem-quotas-on-ubuntu-18-04> for information about how to set filesystem quotas on Ubuntu 18.04 and later.

8.2. Switching Between RAID 0 and RAID 5

As supplied from the factory, the RAID level of the DGX A100 RAID array is RAID 0, which provides the maximum storage capacity but does not provide any redundancy.

If one SSD in the array fails, all data stored on the array is lost. If you are willing to accept reduced capacity in return for some level of protection against failure of a SSD, you can change the level of the RAID array to RAID 5. If you change the RAID level from RAID 0 to RAID 5, the total storage capacity of the RAID array is reduced.

Before you change the RAID level of the DGX A100 RAID array, back up all data on the array that you want to preserve. Changing the RAID level of the DGX A100 RAID array erases all data stored on the array.

The DGX A100 software includes the `configure_raid_array.py` custom script, which you can use to change the level of the RAID array without unmounting the RAID volume.

- To change the RAID level to RAID 5, run the following command:

```
$ sudo configure_raid_array.py -m raid5
```

After you change the RAID level to RAID 5, the RAID array is rebuilt. A RAID array that is being rebuilt is online and ready to be used, but a check on the health of the DGX system reports the status of the RAID volume as unhealthy.

The time required to rebuild the RAID array depends on the workload on the system. On an idle system, the rebuild will take about 30 minutes to complete.

- ▶ To change the RAID level to RAID 0, run the following command:

```
$ sudo configure_raid_array.py -m raid0
```

To confirm that the RAID level was changed as required, run the `lsblk` command. The entry in the TYPE column for each SSD in the RAID array indicates the RAID level of the array.

8.3. Configuring Support for Custom Drive Partitioning

DGX A100 systems incorporate data drives configured as RAID 0 by default. You can alter the default configuration by adding or removing drives, or by switching between a RAID 0 configuration and a RAID 5 configuration.

If you alter the default configuration, you must let NVSM know so that the utility does not flag the configuration as an error, and so that NVSM can continue to monitor the health of the drives.

1. Edit `/etc/nvsm/nvsm.config` and set the `use_standard_config_storage` parameter to `false`.

```
"use_standard_config_storage":false
```

2. Restart NVSM.

```
$ systemctl restart nvsm
```

If you restore the drive partition back to the default configuration, set the parameter back to `true`.

Chapter 9. Updating and Restoring the Software

This section provides information about how to update or restore software on your DGX A100 system.

9.1. Updating the DGX A100 Software

You must register your DGX A100 system to receive email notification whenever a new software update is available.

These instructions explain how to update the DGX A100 software through an internet connection to the NVIDIA public repository. The process updates a DGX A100 system image to the latest released versions of the entire DGX A100 software stack, including the drivers, for the latest version within a specific release.

Refer to the [DGX OS 5 User Guide](#) for instructions on upgrading from one release to another (for example, from Release 4 to Release 5).

9.1.1. Connectivity Requirements for Software Updates

Before attempting to perform the update, verify that the DGX A100 system network connection can access the public repositories and that the connection is not blocked by a firewall or proxy.

Enter the following on the DGX A100 system.

```
$ wget -O f1-changelogs http://changelogs.ubuntu.com/meta-release-lts
$ wget -O f1-changelogs http://changelogs.ubuntu.com/meta-release-lts
$ wget -O f2-archive http://archive.ubuntu.com/ubuntu/dists/bionic/Release
$ wget -O f3-usarchive http://us.archive.ubuntu.com/ubuntu/dists/bionic/Release
$ wget -O f4-security http://security.ubuntu.com/ubuntu/dists/bionic/Release
$ wget -O f5-download http://download.docker.com/linux/ubuntu/dists/bionic/Release
$ wget -O f6-international http://international.download.nvidia.com/dgx/repos/
bionic/
dists/bionic/Release
$ wget -O f7-focal-repo https://repo.download.nvidia.com/baseos/ubuntu/focal/x86_64/
dists/focal/Release
All the wget commands should be successful and there should be seven files in the
directory with non-zero content.
```

9.1.2. Update Instructions

Here are the steps to update the software on your DGX A100 system.



CAUTION: These instructions update all software for which updates are available from your configured software sources, including applications that you installed yourself. If you want to prevent an application from being updated, you can instruct the Ubuntu package manager to keep the current version. Refer to [Introduction](#) for more information.

Perform the updates using commands on the DGX A100 console.

1. Run the package manager.

```
$ sudo apt update
```

2. Check to see which software will get updated.

```
$ sudo apt full-upgrade -s
```

To prevent an application from being updated, instruct the Ubuntu package manager to keep the current version. See “Introduction to Holding Packages”.

3. Upgrade to the latest version.

```
$ sudo apt full-upgrade
```

4. Answer any questions that appear.

Most questions require a Yes or No response. If asked to select the grub configuration to use, select the current one on the system.

Other questions will depend on what other packages were installed before the update and how those packages interact with the update. Typically, you can accept the default option when prompted.

5. Reboot the system.

9.2. Restoring the DGX A100 Software Image

If the DGX A100 software image becomes corrupted or the OS SSD was replaced after a failure, restore the DGX A100 software image to its original factory condition from a pristine copy of the image.

The process for restoring the DGX A100 software image is as follows:

1. Obtain an ISO file that contains the image from NVIDIA Enterprise Support as explained in [Obtaining the DGX A100 Software ISO Image and Checksum File](#).
2. Restore the DGX A100 software image from this file either remotely through the BMC or locally from a bootable USB flash drive.
 - ▶ If you are restoring the image remotely, follow the instructions in [Remotely Reimaging the System](#).

- ▶ If you are restoring the image locally, prepare a bootable USB flash drive and restore the image from the USB flash drive as explained in the following topics:
 - ▶ [Creating a Bootable Installation Medium](#)
 - ▶ [Remotely Reimaging the System](#)



Note: The DGX OS Server software is restored on one of the two NVMe M.2 drives. When the system is booted after restoring the image, software RAID begins the process rebuilding the RAID 1 array, which creates a mirror of (or resynchronizing) the drive that contains the software. System performance might be affected during the RAID 1 rebuild process, which can take an hour to complete.

9.2.1. Obtaining the DGX A100 Software ISO Image and Checksum File

To ensure that you restore the latest available version of the DGX A100 software image, obtain the current ISO image file from NVIDIA Enterprise Support. A checksum file is provided for the image to enable you to verify the bootable installation medium that you create from the image file.

1. Log on to the [NVIDIA Enterprise Support \(https://nvid.nvidia.com/dashboard/\)](https://nvid.nvidia.com/dashboard/) site.
2. Click the Announcements tab to locate the download links for the DGX A100 software image.
3. Download the ISO image and its checksum file and save them to your local disk. The ISO image is also available in an archive file. If you download the archive file, be sure to extract the ISO image before proceeding.

9.2.2. Remotely Reimaging the System

These instructions describe how to reimage the system remotely through the BMC. For information about how to restore the system locally, see [Reimaging the System from a USB Flash Drive](#).

Before reimaging the system remotely, ensure that the correct DGX A100 software image is saved to your local disk. For more information, see [Obtaining the DGX A100 Software ISO Image and Checksum File](#).

1. Log in to the BMC.
2. Click Remote Control and then click Launch KVM.
3. Set up the ISO image as virtual media.
 - a). From the top bar, click Browse File and then locate the re-image ISO file and click Open.
 - b). Click Start Media.
4. Reboot, install the image, and complete the DGX A100 system setup.
 - a). From the top menu, click Power and then select Reset Server.

- b). Click OK at the Power Control dialogs, then wait for the system to power down and then come back online.
 - c). As the system boots, press [F11] when the NVIDIA logo appears to get to the boot menu.
 - d). Browse to locate the Virtual CD that corresponds to the inserted ISO, then boot the system from it.
 - e). When the system boots up, select one of the following options from the GRUB menu:
 - ▶ Install DGX OS <version>: Install DGX OS and reformat data RAID
 - ▶ Install DGX OS <version> Without Reformatting Data RAID
 - ▶ Advanced Installation Options: Select if you want to install with an encrypted root filesystem, then select one of the following options:
 - ▶ Install DGX OS <version> With Encrypted Root
 - ▶ Install DGX OS <version> With Encrypted Root and Without Reformatting Data RAID
- If you are an advanced user who is not using the RAID disks as cache and want to keep data on the RAID disks, then select one of the “Without Reformatting Data RAID” options. See the section “Retaining the RAID Partition While Installing the OS” for more information.
- f). Press Enter.

The DGX A100 system will reboot from ISO image and proceed to install the image. This can take approximately 15 minutes.



Note: The Mellanox InfiniBand driver installation can take up to 30 minutes, depending on how many cards undergo a firmware update.

After the installation is completed, the system ejects the virtual CD and then reboots into the OS.

Refer to [First Boot Setup](#) for the steps to take when booting up the DGX A100 system for the first time after a fresh installation.

9.2.3. Creating a Bootable Installation Medium

After obtaining an ISO file that contains the DGX OS Server software image from NVIDIA Enterprise Support, create a bootable installation medium, such as a USB flash drive or DVD-ROM, that contains the image.

- ▶ If you are creating a bootable USB flash drive, follow the instructions for the platform that you are using:
 - ▶ On a text-only Linux distribution, see [Creating a Bootable USB Flash Drive by Using the dd Command](#).

- ▶ On Ubuntu Desktop, see [#unique_106](#).
- ▶ On Windows, see [Creating a Bootable USB Flash Drive by Using Akeo Rufus](#).
- ▶ If you are creating a bootable DVD-ROM, you can use any of the methods described in [Burning the ISO on to a DVD \(https://help.ubuntu.com/community/BurningIsoHowto#Burning_the_ISO_on_to_a_DVD\)](https://help.ubuntu.com/community/BurningIsoHowto#Burning_the_ISO_on_to_a_DVD) on the Ubuntu Community Help Wiki.



Note: The ISO file that contains software image for some DGX OS Server releases is greater than the 4.7 GB capacity of a single-layer DVD-ROM. You cannot install these releases from a bootable DVD-ROM because installation of DGX OS Server from a dual-layer DVD-ROM is not supported. Check the size of the ISO file that contains the DGX OS Server software image before creating a bootable DVD-ROM.

9.2.3.1. Creating a Bootable USB Flash Drive by Using the `dd` Command

On a Linux system, you can use the `dd` (<http://manpages.ubuntu.com/manpages/bionic/en/man1/dd.1.html>) command to create a bootable USB flash drive that contains the DGX OS software image.



Note: To ensure that the resulting flash drive is bootable, use the `dd` command to perform a device bit copy of the image. If you use other commands to perform a simple file copy of the image, the resulting flash drive may not be bootable.

Ensure that the following prerequisites are met:

- ▶ The correct DGX OS software image is saved to your local disk.
For more information, see [Obtaining the Software ISO Image and Checksum File](#).
- ▶ The USB flash drive meets the following requirement:
 - ▶ The USB flash drive has a capacity of at least 16 GB.
 - ▶ This requirement applies only to DGX A100: The partition scheme on the USB flash drive is a GPT partition scheme for UEFI.

1. Plug the USB flash drive into one of the USB ports of your Linux system.
2. Obtain the device name of the USB flash drive by running the `lsblk` (<http://manpages.ubuntu.com/manpages/bionic/man8/lsblk.8.html>) command.

```
lsblk
```

You can identify the USB flash drive from its size, which is much smaller than the size of the SSDs in the DGX software, and from the mount points of any partitions on the drive, which are under `/media`.

In the following example, the device name of the USB flash drive is `sde`.

```
~$ lsblk
```

```

NAME      MAJ:MIN RM   SIZE RO TYPE MOUNTPOINT
sda        8:0    0   1.8T  0 disk
|_sda1     8:1    0   121M  0 part /boot/efi
|_sda2     8:2    0   1.8T  0 part /
sdb        8:16   0   1.8T  0 disk
|_sdb1     8:17   0   1.8T  0 part
sdc        8:32   0   1.8T  0 disk
sdd        8:48   0   1.8T  0 disk
sde        8:64   1    7.6G  0 disk
|_sde1     8:65   1    7.6G  0 part /media/deeplearner/DGXSTATION
~$

```

3. As root, convert and copy the image to the USB flash drive.

```
$ sudo dd if=path-to-software-image bs=2048 of=usb-drive-device-name
```



CAUTION: The `dd` command erases all data on the device that you specify in the `of` option of the command. To avoid losing data, ensure that you specify the correct path to the USB flash drive.

9.2.3.2. Creating a Bootable USB Flash Drive by Using Akeo Rufus

On a Windows system, you can use the [Akeo Reliable USB Formatting Utility \(Rufus\)](https://rufus.akeo.ie/) (<https://rufus.akeo.ie/>) to create a bootable USB flash drive that contains the DGX OS software image.

Ensure that the following prerequisites are met:

- ▶ The correct DGX OS software image is saved to your local disk. For more information, see [Obtaining the Software ISO Image and Checksum File](#).
- ▶ The USB flash drive has a capacity of at least 8 GB.

1. Plug the USB flash drive into one of the USB ports of your Windows system.
2. Download and launch the [Akeo Reliable USB Formatting Utility \(Rufus\)](https://rufus.akeo.ie/) (<https://rufus.akeo.ie/>).

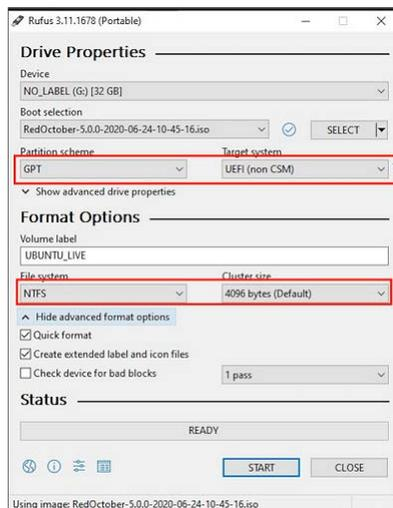

3. In Drive Properties, select the following options:
 - a). In Boot selection, click SELECT, locate, and select the DGX OS software image.
 - b). In Partition scheme, select GPT.
 - c). In Target System, select UEFI (non CSM).
4. In Format Options, select the following options:
 - a). In File system, select NTFS.
 - b). In Cluster Size, select 4096 bytes (Default).
5. Click Start.
Because the image is a hybrid ISO file, you are prompted to select whether to write the image in ISO Image (file copy) mode or DD Image (disk image) mode.

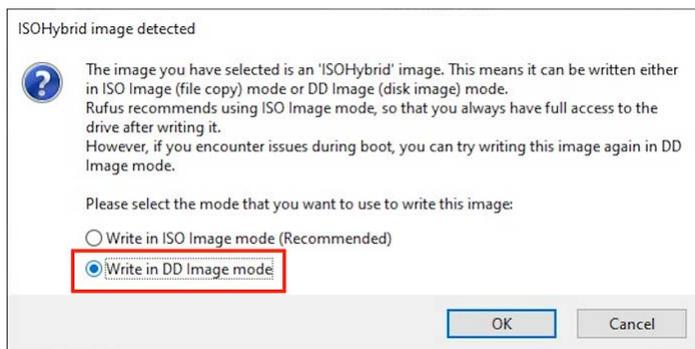

6. Select Write in ISO Image mode and click OK.

9.3. Reimaging the System from a USB Flash Drive

Explain the benefits of the task, the purpose of the task, who should perform the task, and when to perform the task in 50 words or fewer.

Context for the current task.

1. A task step.
2. Another task step.

9.4. Installation Options

Explain what the concept is and why the reader should care about it in 50 words or fewer.

Concept definition.

9.4.1. Retaining the RAID Partition While Installing the OS

The reimaging process creates a fresh installation of the DGX OS. During the OS installation or reimage process, you are presented with a boot menu when booting the installer image.

The default selection is Install DGX Software. The installation process then repartitions all the SSDs, including the OS SSD as well as the RAID SSDs, and the RAID array is mounted as `/raid`. This overwrites any data or file systems that might exist on the OS disk as well as the RAID disks.

Since the RAID array on the DGX A100 system is intended to be used as a cache and not for long-term data storage, this should not be disruptive. However, if you are an advanced user and have set up the disks for a non-cache purpose and want to keep the data on those drives, then select the Install DGX Server without formatting RAID option at the boot menu during the boot installation. This option retains data on the RAID disks and performs the following:

- ▶ Installs the cache daemon but leaves it disabled by commenting out the `RUN=yes` line in `/etc/default/cachefilesd` entry.
- ▶ Creates a `/raid` directory, leaves it out of the file system table by commenting out the containing `/raid` in `/etc/fstab`.
- ▶ Does not format the RAID disks.

When the installation is completed, you can repeat any configurations steps that you had performed to use the RAID disks as other than cache disks.

You can always choose to use the RAID disks as cache disks later by enabling `cachefilesd` and adding `/raid` to the file system table as follows:

1. Uncomment the `#RUN=yes` line in `/etc/default/cachefilesd`
2. Uncomment the `/raid` line in `etc/fstab`.
3. Run the following:

- a). Mount `/raid`.

```
$ sudo mount /raid
```

- b). Start the cache daemon.

```
$ systemctl start cachefilesd
```

These changes are preserved across system reboots.

9.4.2. Advanced Installation Option (Encrypted Root - DGX OS 5 or Later)

Selecting this menu item provides the ability to encrypt the root filesystem of the DGX. It should normally only be selected if this is desired.

Selecting Encrypted Root instructs the installer to encrypt the root filesystem. The encryption is fully automated, and users will be required to manually unlock the root

partition by entering a passphrase at the console (either through a direct keyboard and mouse connection or through the BMC) every time the system boots. During the First Boot process (see [First Boot Setup](#)), you are provided the opportunity to create your passphrase for the drive. The passphrase can be changed later if needed.

9.4.3. Boot into Live Environment (DGX OS 5 or Later)

The DGX OS installer image can also be used as a Live image, which means it boots and runs a minimal DGX OS in system memory and does not overwrite anything on the disks in the system.

While this Live mode does not load drivers, and is essentially a simple Ubuntu Server configuration, it can be used as a tool for debugging a system if the disks on the system are not accessible, or otherwise should not be touched.

When booting into the live environment, log in as root (a password is not needed). In a normal operation, this option should not be selected.

9.4.4. Check Disc for Defects (DGX OS 5 or Later)

Here is some information about how to check the disc for defects.

If you are experiencing oddities when installing DGX OS, and suspect the installation media has an issue, selecting this item will do an extensive test of the contents of the install media. It is time consuming, and the installation media generally is not the real source of the problem.

In a normal operation, this option should not be selected.

Chapter 10. Using the BMC

The NVIDIA DGX A100 system comes with a baseboard management controller (BMC) for monitoring and controlling various hardware devices on the system. It monitors system sensors and other parameters.

10.1. Connecting to the BMC

Here are the steps to connect to the BMC on a DGX A100 system. Before you begin, ensure that you have connected the BMC port on the DGX A100 system to your LAN.

1. Open a browser within your LAN and go to `https://<bmc-ip-address>/`.

The BMC is supported on the following browsers:

- ▶ Internet Explorer 11 and later
- ▶ Firefox 29.0 (64-bit) and later
- ▶ Google Chrome 70.0.3538.67 (64-bit) and later

2. Log in.

The BMC dashboard opens.

Toolbar

Menu Bar

Display Area

Firmware	BMC	BIOS	MB FPGA	IMD FPGA	GB FPGA	PSU 0	PSU 1	PSU 2	PSU 3	PSU 4	PSU 5
Primary	0.11.04*	0.10	0.00.09	0.00.09	2.05	1.05	1.05	1.05	1.05	1.05	1.05
Secondary	0.06.00	0.15*	N/A	N/A	N/A	1.05	1.05	1.05	1.05	1.05	1.05
Communication	N/A	N/A	N/A	N/A	N/A	1.05	1.05	1.05	1.05	1.05	1.05

10.2. Overview of BMC Controls

The left-side navigation menu bar on the BMC main page contains the primary controls.

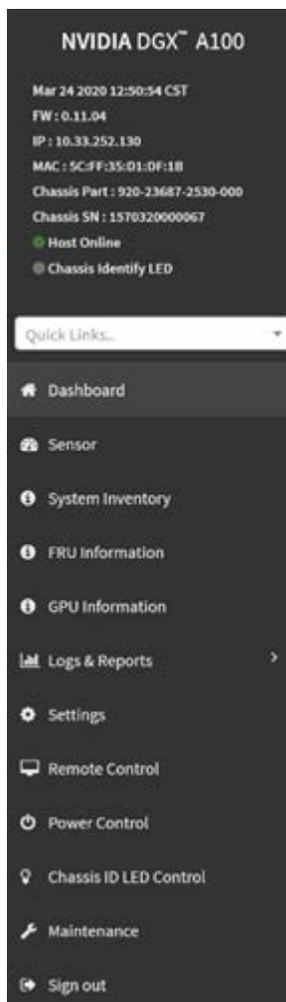

Table 8. BMC Main Controls

Quick Links	Provides quick access to several tasks.
Dashboard	Displays the overall information about the status of the device.
Sensor	Provides status and readings for system sensors, such as SSD, PSUs, voltages, CPU temperatures, DIMM temperatures, and fan speeds.
System Inventory	Displays inventory information of system modules.
FRU Information	System, Processor, Memory Controller, BaseBoard, Power, Thermal, PCIE Device, PCIE Function, and Storage.
GPU Information	Provides basic information on all the GPUs in the systems, including GUID, VBIOS version,

	InfoROM version, and number of retired pages for each GPU.
Logs and Reports	View, and if applicable, download and erase, the IPMI event log, and System, Audit, Video, and POST Code logs.
Settings	Configure the following settings: Captured BSOD, External User Services, KVM Mouse Setting, Log Settings, Media Redirection Settings, Network Settings, PAM Order Settings, Platform Event Filter, Services, SMTP Settings, SSL Settings, System Firewall, User Management, and Video Recording
Remote Control	Opens the KVM Launch page to remotely access the DGX A100 console.
Power Control	Perform the following power actions: Power On, Power Off, Power Cycle, Hard Reset, and ACP/Shutdown
Chassis ID LED Control	Lets you to change the chassis ID LED behavior: Off, Solid On, Blinking On (select from 5 to 255 second blinking intervals).
Maintenance	Perform the following maintenance tasks: Backup Configuration, Firmware Image Location, Firmware Update, Preserve Configuration, Restore Configuration, Restore Factory Defaults, and System Administrator
Sign out	Sign out of the BMC web UI.

10.3. Common BMC Tasks

This section provides information about the most common BMC tasks.

10.3.1. Changing the BMC Login Credentials

Here is information about how you can add or remove users.

1. Select Settings from the left-side navigation menu.
2. Select the User Management card.

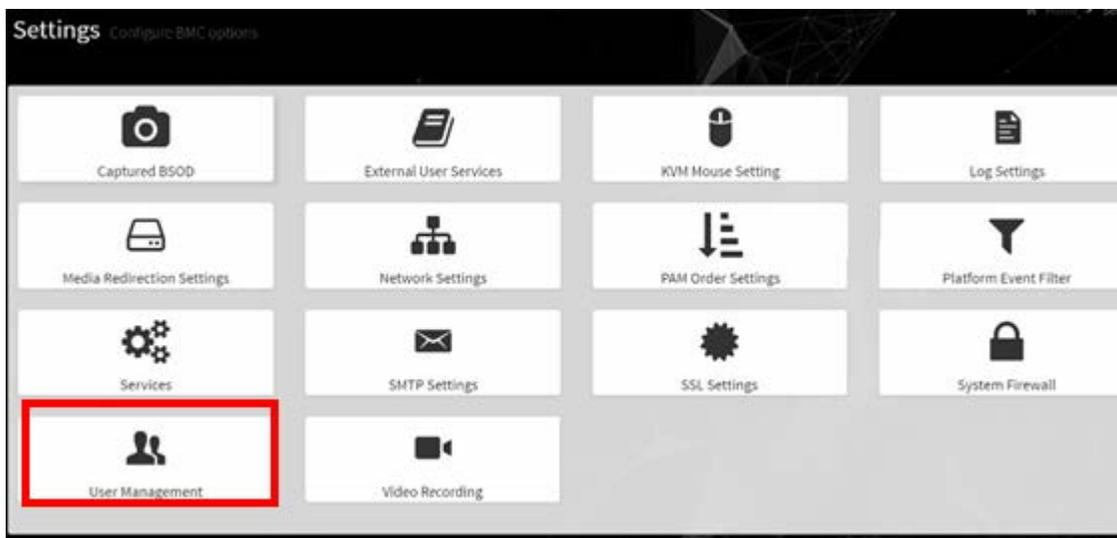

3. Click the Help icon (?) for information about configuring users and creating a password.
4. Log out and then log back in with the new credentials.

10.3.2. Using the Remote Console

Here is some information about how to log in to the remote console.

1. Click Remote Control from the left-side navigation menu.
2. Click Launch KVM to start the remote KVM and access the DGX A100 console.

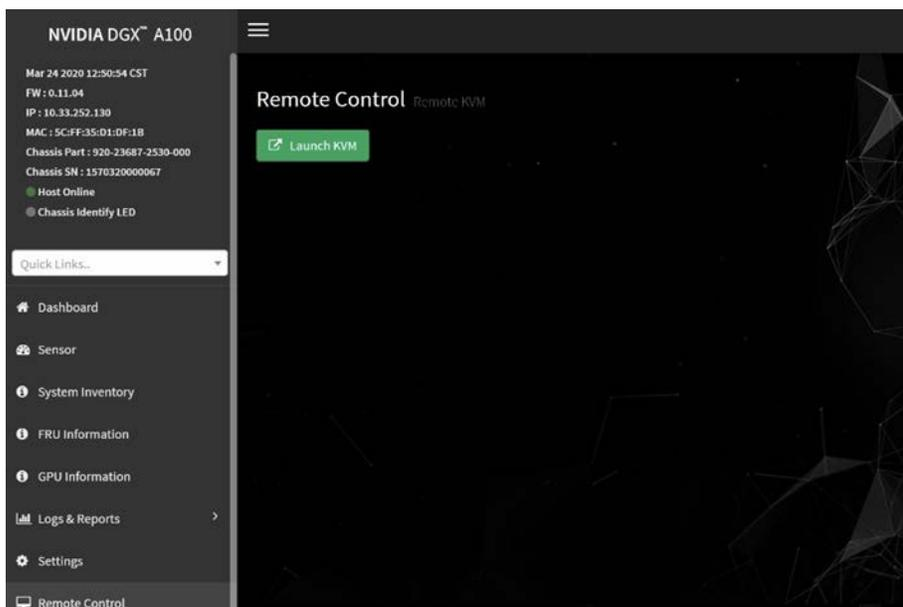

10.3.3. Setting Up Active Directory or LDAP/E-Directory

Here is some information about how you can set up Active Directory or LDAP/E-Directory.

1. From the side navigation menu, click Settings > External User Services .

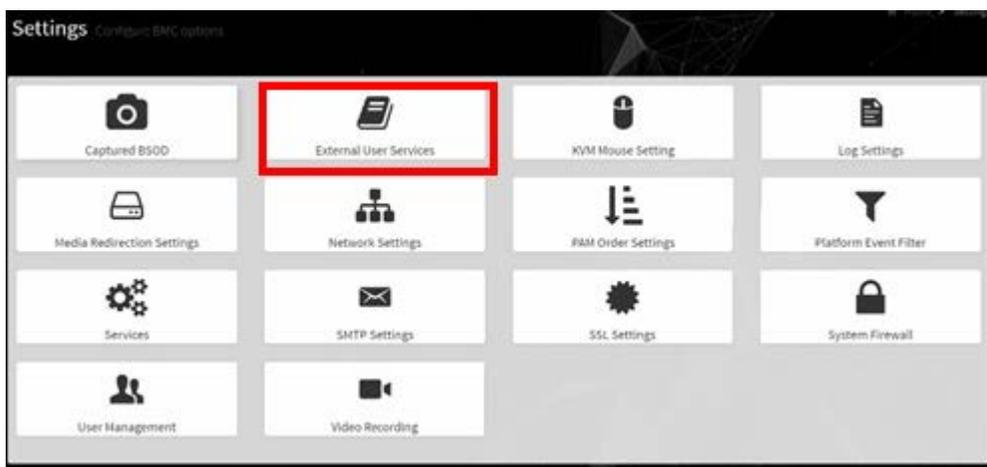

2. Click Active Directory Settings or LDAP/E-Directory Settings and follow the instructions.



10.3.4. LDAP/E-Directory Settings

Setup the BMC for external authentication and authorization using LDAP.

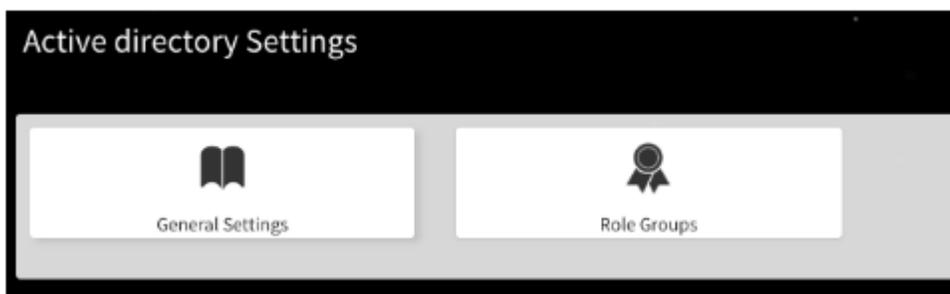

1. Configure the General Settings

The configuration for the General LDAP/E-Directory Settings screen should be fairly straightforward if you know the details about your LDAP service. If it is not clear what is expected, the help explains the fields.

General Active Directory Settings

Enable Active Directory Authentication

SSL

Secret Username
nvidia

Secret Password
sup3rs3cr3t

User Domain Name
nvidia.com

Domain Controller Server Address 1
192.0.2.11

Domain Controller Server Address 2
192.0.2.12

Domain Controller Server Address 3
192.0.2.12

Save

Note: Configuring LDAP to use an Active Directory server is supported. Contact the AD administrator to configure the LDAP details and help with any troubleshooting that may be necessary. Windows server firewall rules may be blocking external connections to the default LDAP ports 389 and 636.

Authoritative Bind to the LDAP service is required, meaning this cannot be configured with *anonymous bind*. The *Bind DN* and *Password* fields are the bind credentials used for every lookup. The *bind* process is the BMC authenticating itself as a valid endpoint, before it can perform any lookup.

The *Search Base* and *Attribute of User Login* are used to convert the BMC login *username* string, to the expected DN string the LDAP server expects.

Finally, click *Save* to validate and store the LDAP settings. If you revisit this page, you will have to re-enter the *Password*.

2. Configure Role Groups

The Role Groups must be configured to assign BMC permissions to the authenticated user, otherwise known as authorization. This is done by mapping an LDAP group membership to BMC permissions.

Note: If no Role Group mapping is created, the authentication will fail, since the user would not have any permissions in the BMC interface.

To add a Role Group, click on one of the cards.

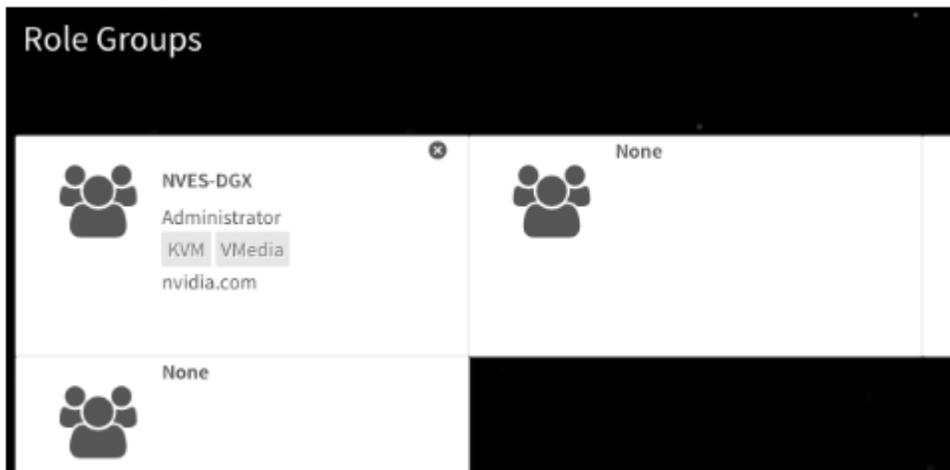

Specify the LDAP group name and group domain to map to the BMC privilege level/permissions. If you are unsure about the settings, contact the LDAP administrator for help.

The *Group Domain* field should be considered the "Group Search Base DN" for the group name lookup.

Note: The LDAP group filter used by the BMC is *not* configurable. The pre-configured group filter searches for the *group name* (CN) with objectClass matching "groupOfNames" or "group".

```
filter=" (&(| (objectClass=groupOfNames) (?objectClass=group)) (cn=dgx_admins)) "
```

Therefore, the LDAP service group structure **MUST** use either of the following:

- ▶ LDAP standard (rfc2256) structural objectClass "groupOfNames", with the member attributes specifying the users assigned to the group.
- ▶ Align with Active Directory structure using objectClass "group"

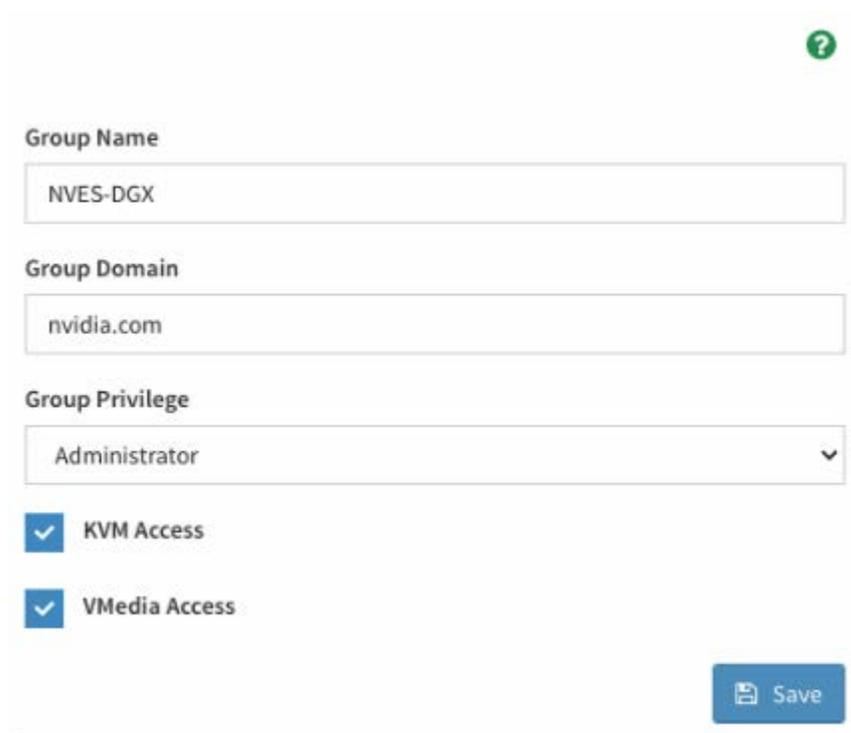

Group Name
NVES-DGX

Group Domain
nvidia.com

Group Privilege
Administrator

KVM Access

VMedia Access

Save

Save the configuration and start authenticating using valid LDAP credentials.

10.3.5. Active Directory Settings

Setup the BMC for external authentication and authorization using Active Directory.

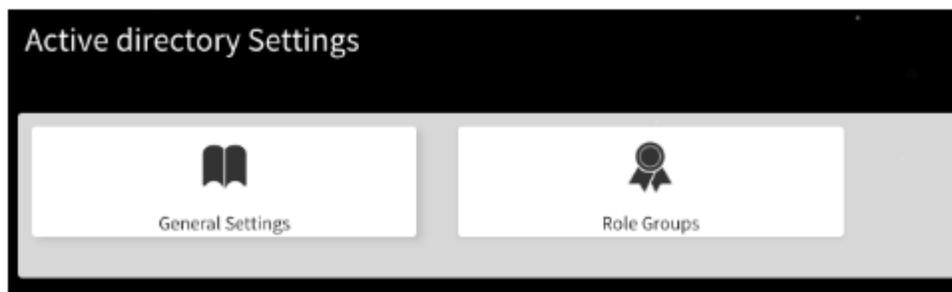

1. Configure the General Settings

The configuration for the General Active Directory Settings screen should be fairly straight forward if you know the details about your Active Directory cluster. If it is not clear what is expected, the help explains the fields.

General Active Directory Settings

Enable Active Directory Authentication

SSL

Secret Username
nvidia

Secret Password
sup3rs3cr3t

User Domain Name
nvidia.com

Domain Controller Server Address 1
192.0.2.11

Domain Controller Server Address 2
192.0.2.12

Domain Controller Server Address 3
192.0.2.12

Save

If you are unsure about the settings, contact the AD administrator for help. You may require an AD admin account to connect the BMC to the AD forest.

The *User Domain Name* must match all or part of the BMC domain name. If the BMC is in a subdomain (bmc.nvex.nvidia.com), then the *User Domain Name* could be set to the subdomain (nvex.nvidia.com), or the parent domain (nvidia.com).



Note: Authentication across domains requires the proper AD trust relationship. This is outside the scope of the docs, but this [reference](#) can be provided.

Finally, click **Save** to validate and store the AD settings. If you revisit this page, you will have to re-enter the Secret Password.

2. Configure Role Groups

The Role Groups must be configured to assign BMC permissions to the authenticated user, otherwise known as authorization. This is done by mapping Active Directory group membership to BMC permissions.

Note: If no Role Group mapping is created, the authentication will fail, since the user would not have any permissions in the BMC interface.

To add a Role Group, click on one of the cards.

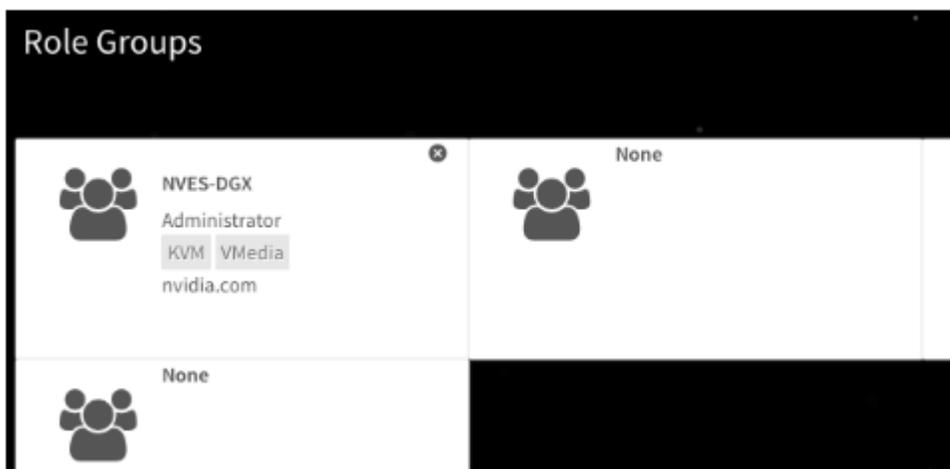

Specify the AD group name and group domain to map to the BMC privilege level/permissions. If you are unsure about the settings, contact the AD administrator for help.

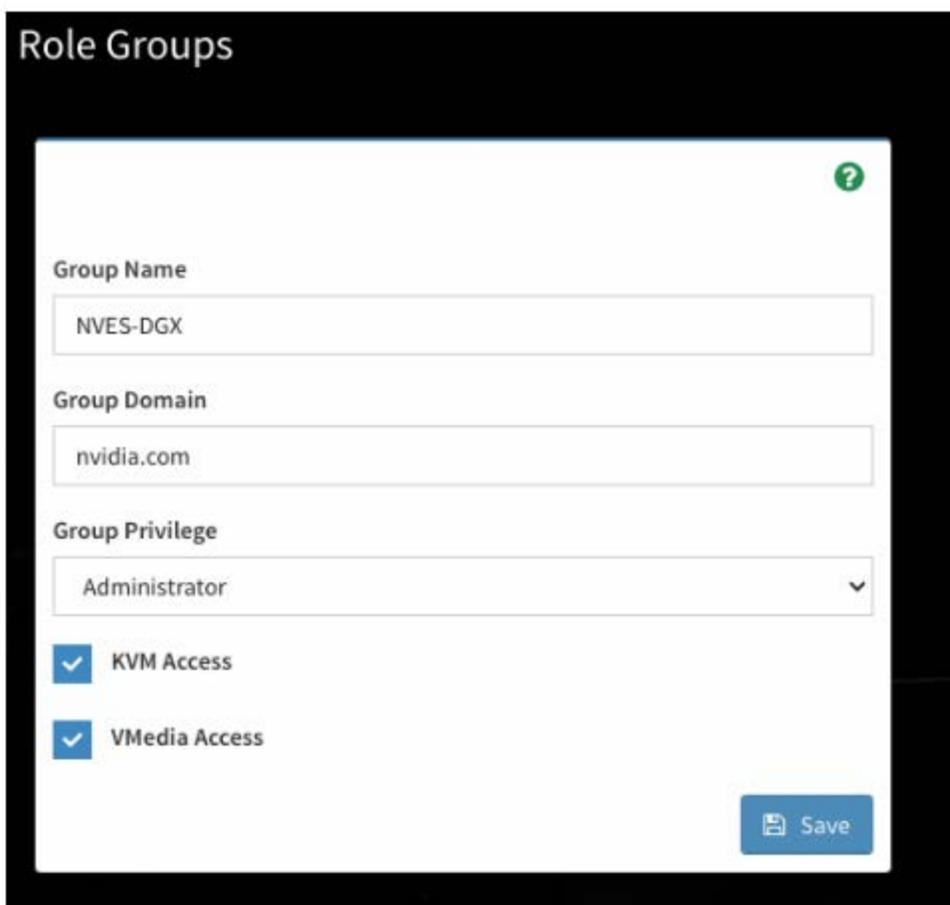
A screenshot of the 'Role Groups' configuration form. The title 'Role Groups' is at the top left. The form contains the following fields: 'Group Name' with the value 'NVES-DGX', 'Group Domain' with the value 'nvidia.com', and 'Group Privilege' with a dropdown menu set to 'Administrator'. Below these fields are two checked checkboxes: 'KVM Access' and 'VMedia Access'. A blue 'Save' button is located at the bottom right of the form. A green question mark icon is in the top right corner of the form area.

Save the configuration and start authenticating using valid AD credentials.

10.3.6. Configuring Platform Event Filters

From the side navigation menu, click Settings and click Platform Event Filters.

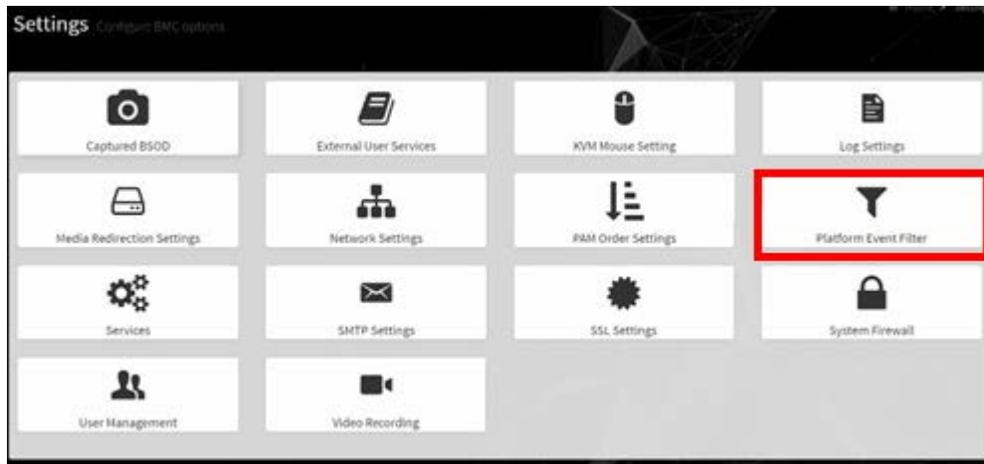

The Event Filters page shows all configured event filters and available slots. You can modify or add new event filter entry on this page.

- ▶ To view available configured and unconfigured slots, click All in the upper-left corner of the page.
- ▶ To view available configured slots, click Configured in the upper-left corner of the page.
- ▶ To view available unconfigured slots, click UnConfigured in the upper-left corner of the page.
- ▶ To delete an event filter from the list, click the x icon.

10.3.7. Uploading or Generating SSL Certificates

You can set up a new certificate by generating a (self-signed) SSL or by uploading an SSL (for example, to use a Trusted CA-signed certificate).

From the side navigation menu, click Settings > External User Services .

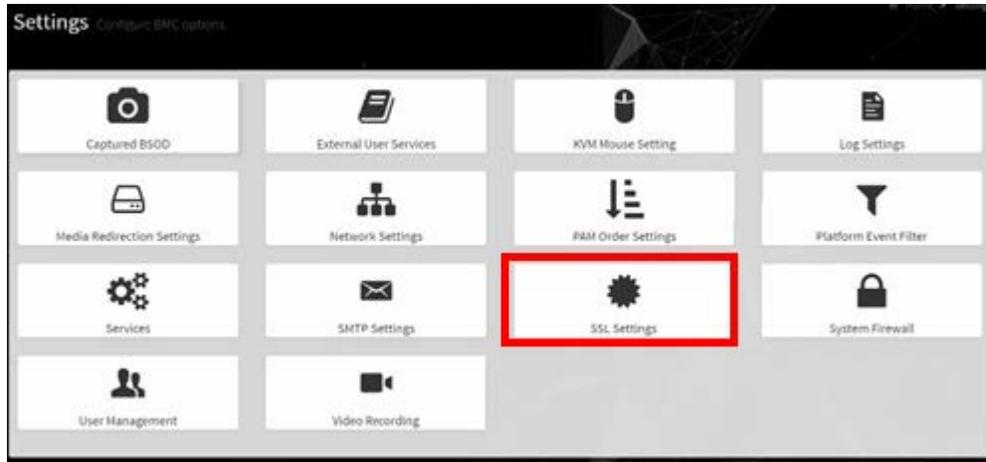

Refer to the following sections for more information:

- ▶ [Viewing the SSL Certificate](#)
- ▶ [Generating an SSL Certificate](#)

10.3.7.1. Viewing the SSL Certificate

To view the SSL certificate, on the SSL Setting page, click View SSL Certificate.

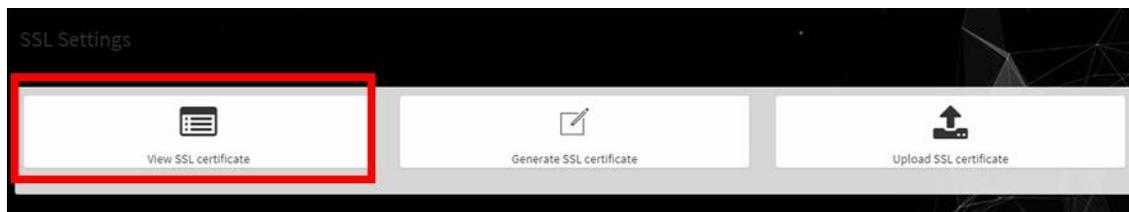

The View SSL Certificate page displays the following basic information about the uploaded SSL certificate:

- ▶ Certificate Version, Serial Number, Algorithm, and Public Key
- ▶ Issuer information
- ▶ Valid Date range
- ▶ Issued to information

10.3.7.2. Generating the SSL Certificate

Here is some information about generating an SSL certificate.

Context for the current task.

1. From the SSL Setting page, select Generate SSL Certificate.

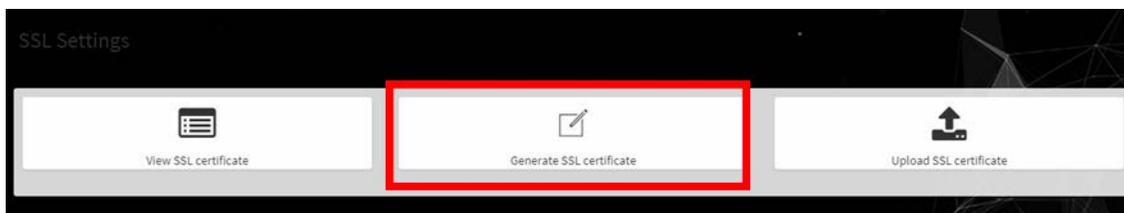

2. Enter the information as described in the following table.

Table 9. BMC Main Controls

Items	Description/Requirements
Common Name (CN)	<p>The common name for which the certificate is to be generated.</p> <ul style="list-style-type: none"> ▶ Maximum length of 64 alpha-numeric characters. ▶ Special characters '#' and '\$' are not allowed.
Organization (O)	<p>The name of the organization for which the certificate is generated.</p> <ul style="list-style-type: none"> ▶ Maximum length of 64 alpha-numeric characters. ▶ Special characters '#' and '\$' are not allowed.
Organization Unit (OU)	<p>Overall organization section unit name for which the certificate is generated.</p> <ul style="list-style-type: none"> ▶ Maximum length of 64 alpha-numeric characters. ▶ Special characters '#' and '\$' are not allowed.
City or Locality (L)	<p>City or Locality of the organization (mandatory)</p> <ul style="list-style-type: none"> ▶ Maximum length of 64 alpha-numeric characters. ▶ Special characters '#' and '\$' are not allowed.
State or Province (ST)	<p>State or Province of the organization (mandatory)</p> <ul style="list-style-type: none"> ▶ Maximum length of 64 alpha-numeric characters.

Items	Description/Requirements
	<ul style="list-style-type: none"> ▶ Special characters '#' and '\$' are not allowed.
Country (C)	Country code of the organization. <ul style="list-style-type: none"> ▶ Only two characters are allowed. ▶ Special characters are not allowed.
Email Address	Email address of the organization (mandatory)
Valid for	Validity of the certificate.
Key Length	Enter a range from 1 to 3650 (days)

3. To generate the new certificate, click Save .

10.3.7.3. Uploading the SSL Certificate

In BMC, you can upload your SSL certificate.

Make sure the certificate and key meet the following requirements:

- ▶ SSL certificates and keys must both use the .pem file extension.
- ▶ Private keys must not be encrypted.
- ▶ SSL certificates and keys must each be less than 3584 bits in size.
- ▶ SSL certificates must be current (not expired).

1. On the SSL Setting page, click Upload SSL Certificate.

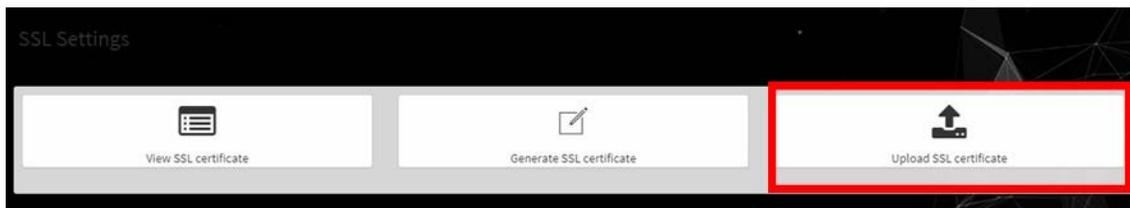

2. Click the New Certificate folder icon, browse to locate the appropriate file, and select it.
3. Click the New Private Key folder icon, browse and locate the appropriate file, and select it.
4. Click Save.

10.3.7.4. Updating the SBIOS Certificate

The CA Certificate for the trusted CA that was used to sign the SSL certificate must be uploaded to allow the SBIOS to authenticate the certificate.

1. Obtain the CA certificate from the signing authority that was used to sign the SSL certificate.
2. Copy the CA certificate onto a USB thumb drive or to /boot/efi on the A100 OS.

3. Access the DGX A100 console from a locally connected keyboard and mouse or through the BMC remote console.
4. Reboot the server
5. To enter BIOS setup menu, when prompted, press DEL.
6. In the BIOS setup menu on the Advanced tab, select Tls Auth Config.

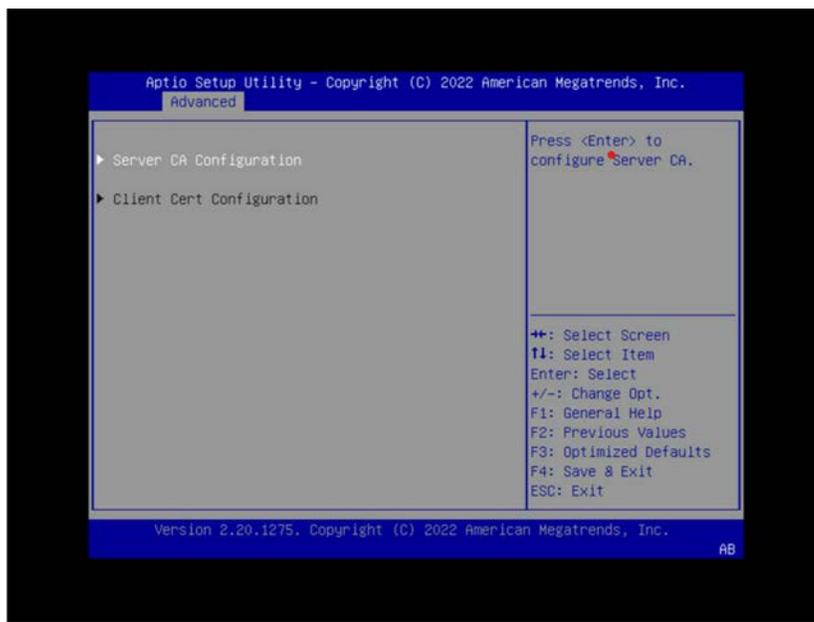

7. Select Server CA Configuration.

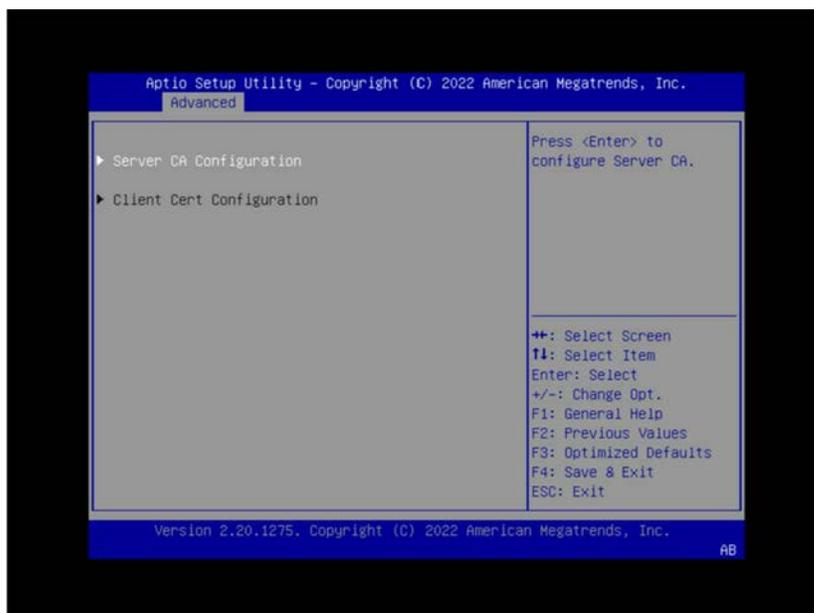

8. Select Enroll Cert.

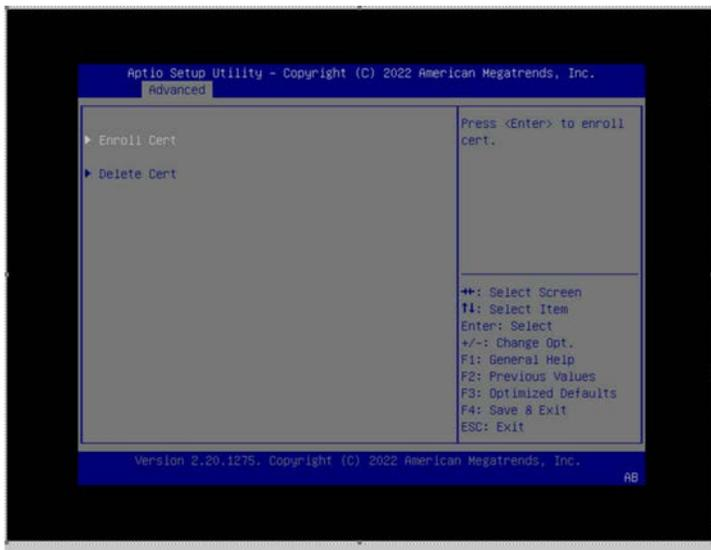

9. Select Enroll Cert Using File.
10. Select the device where you stored the certificate.



11. Navigate the file structure and select the certificate.

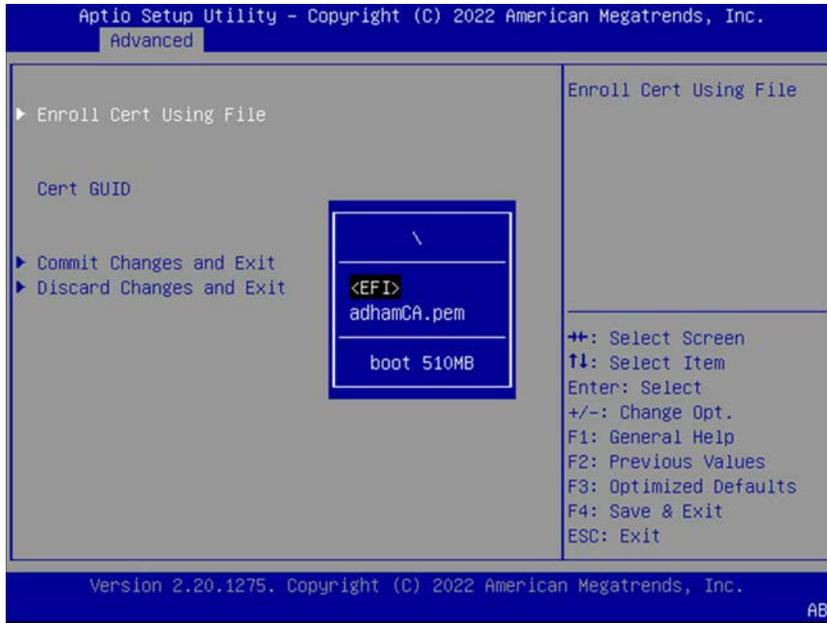

Chapter 11. SBIOS Settings

The NVIDIA DGX A100 system comes with a system BIOS with optimized settings for the DGX system. There might be situations where the settings need to be changed, such as changes in the boot order, changes to enable PXE booting, or changes in the BMC network settings.

Instructions for these use cases are provided in this section.



Important: Do not change settings in the SBIOS other than those described in this or other DGX A100 user documents. Contact NVIDIA Enterprise Services before making other changes.

11.1. Accessing the SBIOS Setup

Here is information about how you can access the SBIOS setup.

1. Access the DGX A100 console, either from a locally connected keyboard and mouse or through the BMC remote console.
2. Reboot the DGX A100.
3. When presented with the SBIOS version screen, press [Del] or [F2] to enter the BIOS Setup Utility.

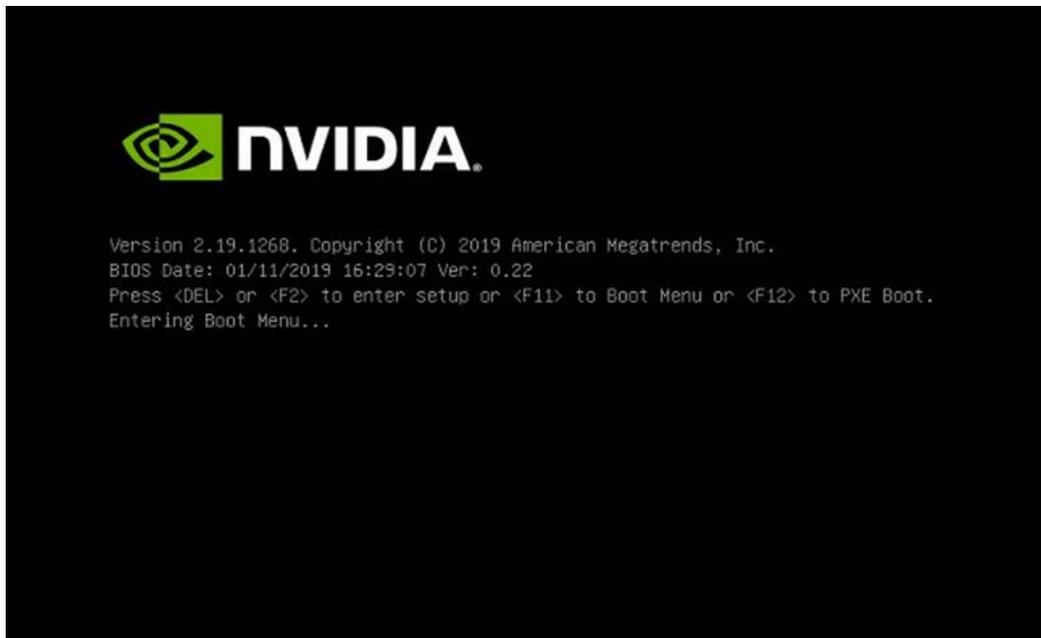

Here are some occasions where it might be necessary to reconfigure settings in the SBIOS:

- ▶ Configuring a BMC Static IP Address Using the System BIOS
- ▶ Enabling the TPM and Preventing the BIOS from Sending Block SID Requests
- ▶ Clearing the TPM

11.2. Configuring the Boot Order

The following instructions describe how to set the boot order at boot time. You can also set the boot order from the SBIOS setup > Boot screen.

1. Access the DGX A100 console, either from a locally connected keyboard and mouse or through the BMC remote console.
2. Reboot the DGX A100.
3. Press [F11] at the NVIDIA splash screen.

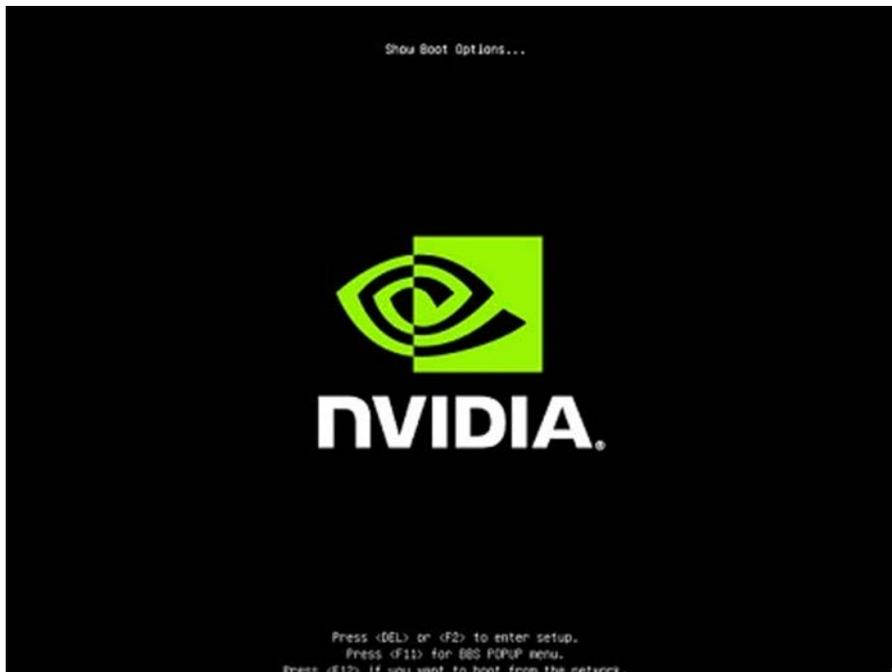

4. Select the boot device.

The following example shows virtual media selected.



11.3. Configuring the local terminal to access the SBIOS settings screen

There are two ways to access the BIOS setup screen, one is through a direct-attached Keyboard and Monitor, and the other is through Serial-over-Lan (SOL) protocol using the IPMI tools.

Below are the instructions on how to configure a terminal with the correct settings to access the SBIOS configuration screens using SOL.

If using the IPMI SOL protocol:

1. When accessing the SBIOS configuration screen, be sure to use the 'xterm' terminal emulator and character encoding is set to `en_UTF-8`
2. Double-check the character encoding by running `echo $LANG`

For Linux desktop users, set the character encoding:

1. `$ sudo localectl set-loCALE LANG=en_US.UTF-8`
2. Type `export LANG=en_UTF-8` to set the locale for the current session
3. Type `xterm` to launch the terminal with the set locale.
4. From within the new xterm, use `ipmitool` to connect to the DGX A100 SOL console:
`ipmitool -I lanplus -H {IP Address} -U admin -P dgxluna.admin sol activate`

For Windows or Macintosh users

Configure terminal application for `en_US.UTF-8` support

Power on or Reboot the system using one of the following interfaces, depending on what the state of the system is:

1. Use the BMC User Interface to power on/reboot, OR
2. From the Operating System command line run `$ sudo reboot`
3. Using the following IPMI command: `$ sudo ipmitool -I lanplus -H {IP Address} -U {userid} -P {password} sol activate` to access the SOL interface using the terminal with the set locale.
4. Press DEL or F2 when the following message comes up as the system is booting.
5. The system should confirm your choice and will bring up the BIOS configuration screen.

Chapter 12. Multi-Instance GPU

Multi-Instance GPU (MIG) is a new capability of the NVIDIA A100 GPU. MIG uses spatial partitioning to carve the physical resources of an A100 GPU into up to seven independent GPU instances. These instances run simultaneously, each with its own memory, cache, and compute streaming multiprocessors. MIG enables the A100 GPU to deliver guaranteed quality of service at up to 7X higher utilization compared to non-MIG enabled GPUs.

MIG enables the following:

- ▶ GPU memory isolation among parallel GPU workloads.
- ▶ Physical allocation of resources used by parallel GPU workloads.

Managing MIG instances is accomplished using the NVIDIA Management Library (NVML) APIs or its command-line utility (`nvidia-smi`). Enablement of MIG requires a GPU reset and hence some system services that manage GPUs should be terminated before enabling MIG.

To enable MIG on all eight GPUs in the system, issue the following.

1. Stop the NVSM and DCGM services.

```
$ sudo systemctl stop nvsm dcmg
```

2. Enable MIG on all eight GPUs.

```
$ sudo nvidia-smi -mig 1
```

If other services are running that prevent you from resetting the GPUs, then reboot the system and skip the next step.

3. Restart the DCGM and NVSM services.

```
$ sudo systemctl start dcmg nvsm
```

To use MIG, see the [MIG User Guide](#), which provides more detailed information about key MIG concepts and deployment considerations and explains how to create MIG instances and how to run Docker containers using MIG.

Chapter 13. Security

This section provides information about security measures in the DGX A100 system.

13.1. User Security Measures

The NVIDIA DGX A100 system is a specialized server designed to be deployed in a data center. It must be configured to protect the hardware from unauthorized access and unapproved use. The DGX A100 system is designed with a dedicated BMC Management Port and multiple Ethernet network ports.

When you install the DGX A100 system in the data center, follow best practices as established by your organization to protect against unauthorized access.

13.1.1. Securing the BMC Port

NVIDIA recommends that you connect the BMC port in the DGX A100 system to a dedicated management network with firewall protection.

If remote access to the BMC is required, such as for a system hosted at a co-location provider, it should be accessed through a secure method that provides isolation from the internet, such as through a VPN server.

13.2. System Security Measures

This section provides information about the security measures that have been incorporated in an NVIDIA DGX A100 system.

13.2.1. Secure Flash of DGX A100 Firmware

Secure Flash is implemented for the DGX A100 to prevent unsigned and unverified firmware images from being flashed onto the system.

13.2.1.1. Encryption

Here is some information about encrypting the DGX A100 firmware.

The firmware encryption algorithm is AES-CBC.

- ▶ The firmware encryption key strength is 128 bits or higher.

- ▶ Each firmware class uses a unique encryption key.
- ▶ Firmware decryption is performed either by the same agent that performs signature check or a more trusted agent in the same COT.

13.2.1.2. Signing

Explain what the concept is and why the reader should care about it in 50 words or fewer.

Concept definition.

13.2.1.3. NVSM Security

For information about security in NVSM, see [Configuring NVSM Security](#).

13.3. Secure Data Deletion

This section explains how to securely delete data from the DGX A100 system SSDs to permanently destroy all the data that was stored there.

This process performs a more secure SSD data deletion than merely deleting files or reformatting the SSDs.

13.3.1. Prerequisites

You need to prepare a bootable installation medium that contains the current DGX OS Server ISO image.

Refer to the following content for more information:

- ▶ [Obtaining the DGX A100 Software ISO Image and Checksum File](#)
- ▶ Creating a Bootable Installation Medium

13.3.2. Instructions

Here are the instructions to securely delete data from the DGX A100 system SSDs.

1. Boot the system from the ISO image, either remotely or from a bootable USB key.
2. At the GRUB menu, select:
 - ▶ (For DGX OS 4): 'Rescue a broken system' and configure the locale and network information.
 - ▶ (For DGX OS 5): 'Boot Into Live Environment' and configure the locale and network information.
3. When prompted to select a root file system, choose Do not use a root file system and then Execute a shell in the installer environment.
4. Log in.
5. Run the following command to identify the devices available in the system:

```
$ nvme list
```

If nvmecli is not installed, then install the CLI as follows and then run nvme list.

DGX OS 4

```
$ dpkg -i /cdrom/extras/pool/main/n/nvme-cli/nvme-cli_1.5-1ubuntu1_amd64.deb
```

DGX OS 5

```
$ dpkg -i /usr/lib/live/mount/rootfs/filesystem.squashfs/curtin/repo/nvme-  
cli_1.9-1ubuntu0.1_amd64.deb
```

6. Run `nvme format -s1` on all storage devices listed.

```
$ nvme format -s1 <device-path>
```

where

<device-path> is the specific storage node as listed in the previous step. For example, `/dev/nvme0n1`.

Chapter 14. Redfish APIs Support

The DGX System firmware supports the ability to manage the system by using an industry standard Redfish interface. This chapter provides details about the Redfish protocol support that is available in the DGX A100 system and how to complete system management functions by using the supported Redfish APIs.

Redfish is a web-based management protocol, and the Redfish server is integrated into the DGX A100 BMC firmware. By default, Redfish support is enabled in the DGX A100 BMC and the BIOS. By using the Redfish interface, administrator-privileged users can browse physical resources at the chassis and system level through a web-based user interface.

Redfish provides information that is categorized under a specific resource end point and Redfish clients can use the end points by using following HTTP methods:

- ▶ GET
- ▶ POST
- ▶ PATCH
- ▶ PUT
- ▶ DELETE

Not all endpoints support all these operations. Refer to the Redfish JSON Schema for more information about the operations. The Redfish server follows the [DSP0266 1.7.0 Specification and Redfish Schema 2019.1](#) documentation. Redfish URIs are accessed by using basic authentication and implementation, so that IPMI users with required privilege can access the Redfish URIs.

14.1. Supported Redfish Features

Here is some information about the Redfish features that are supported in DGX A100.

The following features are supported:

- ▶ Manage user accounts, privileges, and roles
- ▶ Manager Sessions
- ▶ BMC configuration
- ▶ BIOS configuration

- ▶ BIOS boot order management
- ▶ Get PCIe device and functions inventory
- ▶ Get storage Inventory
- ▶ Get system component information and health (PSU, FAN, CPU, DIMM, and so on)
- ▶ Get sensor information (Thermal/Power/Cooling)
- ▶ BMC configuration change/BMC reset
- ▶ System/Chassis power operations
- ▶ Get health event log/advanced system event log
- ▶ Logging Service, which provides critical/informational severity events
- ▶ Event Services (SSE)

Refer to the following documentation for more information:

- ▶ [DMTF Redfish](#) specification
- ▶ [DSP0266 1.7.0 Specification](#)
- ▶ [Redfish Schema 2019.1 Now Available](#)

For a list of the known issues and limitations with Redfish support that are specific to the firmware version you are running, refer to the [DGX A100 System Firmware Update Container Release Notes](#).

Appendix A. Installing Software on Air-Gapped DGX A100 Systems

For security purposes, some installations require that systems be isolated from the internet or outside networks. Since most DGX A100 software updates are accomplished through an over-the-network process with NVIDIA servers, this section explains how updates can be made when using an over-the-network method is not an option. It also includes a process for installing Docker containers.

A.1. Installing NVIDIA DGX A100 Software

There are two ways to install DGX A100 software on an air-gapped DGX A100 system.

One method to update DGX A100 software on an air-gapped DGX A100 system is to download the ISO image, copy it to removable media, and reimage the DGX A100 System from the media. This method is available only for software versions that are available as ISO images for download.

Alternately, you can update the DGX A100 software by performing a network update from a local repository. This method is available only for software versions that are available for over-the-network updates.

A.2. Reimaging the System

Here is some information about how you can reimage your DGX A100 system.



CAUTION: This process destroys all data and software customizations that you have made on the DGX A100 System. Be sure to back up any data that you want to preserve and push any Docker images that you want to keep to a trusted registry.

1. Obtain the ISO image from the NVIDIA Enterprise Services.

- a). a Log in to the [NVIDIA Enterprise Support](#) site, and on the Announcements tab, locate the DGX OS Server image ISO file.
 - b). Download the image ISO file.
2. 2. Refer to the instructions in the Restoring the DGX A100 Software Image for additional instructions.

A.3. Creating a Local Mirror of the NVIDIA and Canonical Repositories

The procedure below describes how to download all the necessary packages to create a mirror of the repositories that are needed to update NVIDIA DGX systems. The steps are specific to versions 4.0.X and 4.1.X, but they can be edited to work with other versions. For more information on DGX OS versions and the release notes available, visit <https://docs.nvidia.com/dgx/dgx-os-server-release-notes/index.html#dgx-os-release-number-scheme>. For more information on how to upgrade from versions 4.0.x to 4.1.x, review the release notes: <https://docs.nvidia.com/dgx/pdf/DGX-OS-server-4.1-relnotes-update-guide.pdf>.



Note: These procedures apply only to upgrades within the same major release, such as 4.x → 4.y. It does not support upgrades across major releases, such as 3.x → 4.x.

A.4. Creating the Mirror in a DGX OS 4 System

The instructions in this section are to be performed on a system with network access. Here are the prerequisites:

- ▶ A system installed with Ubuntu OS is needed to create the mirror because there are several Ubuntu tools that need to be used.
- ▶ You must be logged in to the system installed with Ubuntu OS as an administrator user because this procedure requires `sudo` privileges.
- ▶ The system must contain enough storage space to replicate the repositories to a file system. The space requirement could be as high as 250 GB.
- ▶ An efficient way to move large amount of data is needed, for example, shared storage in a DMZ, or portable USB drives that can be brought into the air-gapped area.

The data will need to be moved to the systems that need to be updated. Make sure that any portable drives are formatted using ext4 or FAT32.

1. Make sure the storage device is attached to the system with network access and identify the mount point of the device.

Example mount point used in these instructions: `/media/usb/repository`

2. Install the `apt-mirror` package.

```
$ sudo apt update
$ sudo apt install apt-mirror
```

3. Change the ownership of the target directory to the `apt-mirror` user in the `apt-mirror` group.

```
$ sudo chown apt-mirror:apt-mirror /media/usb/repository
```

The target directory must be owned by the user `apt-mirror` or the replication will not work.

4. Configure the path of the destination directory in `/etc/apt/mirror.list` and use the included list of repositories below to retrieve the packages for both Ubuntu base OS and the NVIDIA DGX OS packages.

```
##### config #####
#
set base_path /media/usb/repository #/your/path/here
#
# set mirror_path $base_path/mirror
# set skel_path $base_path/skel
# set var_path $base_path/var
# set cleanscript $var_path/clean.sh
# set defaultarch <running host architecture>
# set postmirror_script $var_path/postmirror.sh
set run_postmirror 0
set nthreads 20
set _tilde 0
#
##### end config #####
# Standard Canonical package repositories:
deb http://security.ubuntu.com/ubuntu bionic-security main
deb http://security.ubuntu.com/ubuntu bionic-security universe
deb http://security.ubuntu.com/ubuntu bionic-security multiverse
deb http://archive.ubuntu.com/ubuntu/ bionic main multiverse universe
deb http://archive.ubuntu.com/ubuntu/ bionic-updates main multiverse universe
#
deb-i386 http://security.ubuntu.com/ubuntu bionic-security main
deb-i386 http://security.ubuntu.com/ubuntu bionic-security universe
deb-i386 http://security.ubuntu.com/ubuntu bionic-security multiverse
deb-i386 http://archive.ubuntu.com/ubuntu/ bionic main multiverse universe
deb-i386 http://archive.ubuntu.com/ubuntu/ bionic-updates main multiverse
universe
#
# DGX specific repositories:
deb http://international.download.nvidia.com/dgx/repos/bionic bionic main
restricted universe multiverse
deb http://international.download.nvidia.com/dgx/repos/bionic bionic-updates main
restricted universe multiverse
deb http://international.download.nvidia.com/dgx/repos/bionic bionic-
r418+cuda10.1 main multiverse restricted universe
deb http://international.download.nvidia.com/dgx/repos/bionic bionic-
r450+cuda11.0 main multiverse restricted universe
#
deb-i386 http://international.download.nvidia.com/dgx/repos/bionic bionic main
restricted universe multiverse
deb-i386 http://international.download.nvidia.com/dgx/repos/bionic bionic-updates
main restricted universe multiverse
# Only for DGX OS 4.1.0
deb-i386 http://international.download.nvidia.com/dgx/repos/bionic bionic-
r418+cuda10.1 main multiverse restricted universe
# Clean unused items
clean http://archive.ubuntu.com/ubuntu
clean http://security.ubuntu.com/ubuntu
```

5. Run `apt-mirror` and wait for it to finish downloading content.

This will take a long time depending on the network connection speed.

```
$ sudo apt-mirror
```

6. Eject the removable storage with all packages.

```
$ sudo eject /media/usb/repository
```

A.5. Configuring the Target Air-Gapped DGX OS 4 System

The instructions in this section are to be performed on the target air-gapped DGX system.

Here are the prerequisites:

- ▶ The target air-gapped DGX system is installed, has gone through the first boot process, and is ready to be updated with the latest packages.
- ▶ The USB storage device on which the mirrors were created is attached to the target DGX system.

There are other ways to transfer the data that are not covered in this document as they will depend on the data center policies for the air-gapped environment.

1. Mount the storage device on the air-gapped system to `/media/usb/repository` for consistency.
2. Configure the `apt` (<http://manpages.ubuntu.com/manpages/bionic/en/man8/apt.8.html>) command to use the file system as the repository in the file `/etc/apt/sources.list` by modifying the following lines.

```
deb file:///media/usb/repository/mirror/security.ubuntu.com/ubuntu bionic-security main
deb file:///media/usb/repository/mirror/security.ubuntu.com/ubuntu bionic-security universe
deb file:///media/usb/repository/mirror/security.ubuntu.com/ubuntu bionic-security multiverse
deb file:///media/usb/repository/mirror/archive.ubuntu.com/ubuntu/ bionic main multiverse universe
deb file:///media/usb/repository/mirror/archive.ubuntu.com/ubuntu/ bionic-updates main multiverse universe
```

3. Configure `apt` to use the NVIDIA DGX OS packages in the file `/etc/apt/sources.list.d/dgx.list`.

```
deb file:///media/usb/repository/mirror/international.download.nvidia.com/dgx/repos/bionic bionic main multiverse restricted universe
```

4. If present, remove the file `/etc/apt/sources.list.d/docker.list` as it is no longer needed and removing it will eliminate error messages during the update process.
5. (For DGX OS Release 4.1 and later only) Configure `apt` to use the NVIDIA DGX OS packages in the file `/etc/apt/sources.list.d/dgx-bionic-r418-cuda10-1-repo.list`.

```
$ echo "deb file:///media/usb/repository/mirror/international.download.nvidia.com/dgx/repos/bionic/ bionic-r418+cuda10.1 main multiverse restricted universe" | sudo tee /etc/apt/sources.list.d/dgx-bionic-r418-cuda10-1-repo.list
```

6. Optional: (For DGX OS Release 4.5 and later only) If you want to use the R450 NVIDIA graphics driver and CUDA Toolkit 11.0, configure `apt` to use the NVIDIA DGX OS packages in the file `/etc/apt/sources.list.d/dgx-bionic-r450-cuda11-0-repo.list`.

```
$ echo "deb file:///media/usb/repository/mirror/international.download.nvidia.com/dgx/
repos/bionic/ bionic-r450+cuda11.0 main multiverse restricted universe" | sudo tee /etc/
apt/sources.list.d/dgx-bionic-r450-cuda11-0-repo.list
```



Note: If you want to continue using earlier releases, for example the R418 NVIDIA graphic driver and CUDA Toolkit 10.1, omit this step.

7. Edit the file `/etc/apt/preferences.d/nvidia` to update the Pin parameter as follows.

```
Package: *
#Pin: origin international.download.nvidia.com
Pin: release o=apt-pin-parameter-air-gap
Pin-Priority: 600
```

8. Update the `apt` repository.

```
$ sudo apt update
```

Output from this command is similar to the following example.

```
Get:1 file:/media/usb/repository/mirror/security.ubuntu.com/ubuntu bionic-
security InRelease [88.7 kB]
Get:1 file:/media/usb/repository/mirror/security.ubuntu.com/ubuntu bionic-
security InRelease [88.7 kB]
Get:2 file:/media/usb/repository/mirror/archive.ubuntu.com/ubuntu bionic
InRelease [242 kB]
Get:2 file:/media/usb/repository/mirror/archive.ubuntu.com/ubuntu bionic
InRelease [242 kB]
Get:3 file:/media/usb/repository/mirror/archive.ubuntu.com/ubuntu bionic-updates
InRelease [88.7 kB]
Get:4 file:/media/usb/repository/mirror/international.download.nvidia.com/dgx/
repos/bionic bionic-r418+cuda10.1 InRelease [13.0 kB]
Get:5 file:/media/usb/repository/mirror/international.download.nvidia.com/dgx/
repos/bionic bionic-r450+cuda11.0 InRelease [7070 B]
Get:5 file:/media/usb/repository/mirror/international.download.nvidia.com/dgx/
repos/bionic bionic-r450+cuda11.0 InRelease [7070 B]
Get:6 file:/media/usb/repository/mirror/international.download.nvidia.com/dgx/
repos/bionic bionic InRelease [13.1 kB]
Get:3 file:/media/usb/repository/mirror/archive.ubuntu.com/ubuntu bionic-updates
InRelease [88.7 kB]
Get:4 file:/media/usb/repository/mirror/international.download.nvidia.com/dgx/
repos/bionic bionic-r418+cuda10.1 InRelease [13.0 kB]
Get:6 file:/media/usb/repository/mirror/international.download.nvidia.com/dgx/
repos/bionic bionic InRelease [13.1 kB]
Hit:7 https://download.docker.com/linux/ubuntu bionic InRelease
Get:8 file:/media/usb/repository/mirror/international.download.nvidia.com/dgx/
repos/bionic bionic-r418+cuda10.1/multiverse amd64 Packages [10.1 kB]
Get:9 file:/media/usb/repository/mirror/international.download.nvidia.com/dgx/
repos/bionic bionic-r450+cuda11.0/multiverse amd64 Packages [17.4 kB]
Get:10 file:/media/usb/repository/mirror/international.download.nvidia.com/dgx/
repos/bionic bionic-r418+cuda10.1/restricted amd64 Packages [10.3 kB]
Get:11 file:/media/usb/repository/mirror/international.download.nvidia.com/dgx/
repos/bionic bionic-r450+cuda11.0/restricted amd64 Packages [26.4 kB]
Get:12 file:/media/usb/repository/mirror/international.download.nvidia.com/dgx/
repos/bionic bionic-r418+cuda10.1/restricted i386 Packages [516 B]
Get:13 file:/media/usb/repository/mirror/international.download.nvidia.com/dgx/
repos/bionic bionic/multiverse amd64 Packages [44.5 kB]
Get:14 file:/media/usb/repository/mirror/international.download.nvidia.com/dgx/
repos/bionic bionic/multiverse i386 Packages [8,575 B]
Get:15 file:/media/usb/repository/mirror/international.download.nvidia.com/dgx/
repos/bionic bionic/restricted i386 Packages [745 B]
```

```
Get:16 file:/media/usb/repository/mirror/international.download.nvidia.com/dgx/
repos/bionic bionic/restricted amd64 Packages [8,379 B]
Get:17 file:/media/usb/repository/mirror/international.download.nvidia.com/dgx/
repos/bionic bionic/universe amd64 Packages [2,946 B]
Get:18 file:/media/usb/repository/mirror/international.download.nvidia.com/dgx/
repos/bionic bionic/universe i386 Packages [496 B]
Reading package lists... Done
Building dependency tree
Reading state information... Done
249 packages can be upgraded. Run 'apt list --upgradable' to see them.
$
```

9. Upgrade the system using the newly configured local repositories.

```
$ sudo apt full-upgrade
```

If you configured `apt` to use the NVIDIA DGX OS packages in the file `/etc/apt/sources.list.d/dgx-bionic-r450-cuda11-0-repo.list`, the NVIDIA graphics driver is upgraded to the R450 driver and the package sources are updated to obtain future updates from the R450 driver repositories.

10. Optional: (For DGX OS Release 4.5 and later only) If you configured `apt` to use the NVIDIA DGX OS packages in the file `/etc/apt/sources.list.d/dgx-bionic-r450-cuda11-0-repo.list` and want to use CUDA Toolkit 11.0, install it.

```
$ sudo apt install cuda-toolkit-11-0
```



Note: If you did not configure `apt` to use the NVIDIA DGX OS packages in the file `/etc/apt/sources.list.d/dgx-bionic-r450-cuda11-0-repo.list`, omit this step. If you try to install CUDA Toolkit 11.0, the attempt fails.

A.6. Configuring the Target Air-Gapped DGX OS 5 System

The instructions in this section are to be performed on the target air-gapped DGX system.

The following are the prerequisites.

- ▶ The target air-gapped DGX system is installed, has gone through the first boot process, and is ready to be updated with the latest packages.
- ▶ The USB storage device on which the mirrors were created is attached to the target DGX system.

There are other ways to transfer the data that are not covered in this document as they will depend on the data center policies for the air-gapped environment.

1. Mount the storage device on the air-gapped system to `/media/usb/repository` for consistency.
2. Configure the `apt` (<http://manpages.ubuntu.com/manpages/bionic/en/man8/apt.8.html>) command to use the file system as the repository in the file `/etc/apt/sources.list` by modifying the following lines.

```
deb file:///media/usb/repository/mirror/security.ubuntu.com/ubuntu focal-security
main multiverse universe restricted
```

```
deb file:///media/usb/repository/mirror/archive.ubuntu.com/ubuntu/ focal main
multiverse universe restricted
deb file:///media/usb/repository/mirror/archive.ubuntu.com/ubuntu/ focal-updates
main multiverse universe restricted
```

3. Configure `apt` to use the NVIDIA DGX OS packages in the `/etc/apt/sources.list.d/dgx.list` file.

```
deb file:///media/usb/repository/mirror/repo.download.nvidia.com/baseos/ubuntu/
focal/x86_64/ focal main dgx
deb file:///media/usb/repository/mirror/repo.download.nvidia.com/baseos/ubuntu/
focal/x86_64/ focal-updates main dgx
```

Configure `apt` to use the NVIDIA CUDA packages in the `/etc/apt/sources.list.d/cuda-compute-repo.list` file.

```
deb file:///media/usb/repository/mirror/developer.download.nvidia.com/compute/
cuda/repos/ubuntu2004/x86_64/ /
```

4. Update the `apt` repository.

```
$ sudo apt update
```

Output from this command is similar to the following example.

```
Get:1 file:/media/usb/repository/mirror/security.ubuntu.com/ubuntu focal-security
InRelease [107 kB]
Get:2 file:/media/usb/repository/mirror/archive.ubuntu.com/ubuntu focal InRelease
[265 kB]
Get:3 file:/media/usb/repository/mirror/archive.ubuntu.com/ubuntu focal-updates
InRelease [111 kB]
Get:4 file:/media/usb/repository/mirror/developer.download.nvidia.com/compute/
cuda/repos/ubuntu2004/x86_64 InRelease
Get:5 file:/media/usb/repository/mirror/repo.download.nvidia.com/baseos/ubuntu/
focal/x86_64 focal InRelease [12.5 kB]
Get:6 file:/media/usb/repository/mirror/repo.download.nvidia.com/baseos/ubuntu/
focal/x86_64 focal-updates InRelease [12.4 kB]
Get:7 file:/media/usb/repository/mirror/developer.download.nvidia.com/compute/
cuda/repos/ubuntu2004/x86_64 Release [697 B]
Get:8 file:/media/usb/repository/mirror/developer.download.nvidia.com/compute/
cuda/repos/ubuntu2004/x86_64 Release.gpg [836 B]
Reading package lists... Done
```

5. Upgrade the system using the newly configured local repositories.

```
$ sudo apt full-upgrade
```

A.7. Installing Docker Containers

This method applies to Docker containers hosted on the NVIDIA NGC Container Registry, and requires that you have an active NGC account.

1. On a system with internet access, log in to the NGC Container Registry by entering the following command and credentials.

```
$ docker login nvcr.io
```

Username:

```
$oauthtoken
```

Password:

```
apikey
```

2. Type `$oauthtoken` exactly as shown for the Username.

This is a special username that enables API key authentication. In place of `apikey`, paste in the API Key text that you obtained from the NGC website.

3. Enter the docker pull command, specifying the image registry, image repository, and tag:

```
$ docker pull nvcr.io/nvidia/repository:tag
```

4. Verify the image is on your system using docker images.

```
$ docker images
```

5. Save the Docker image as an archive.

```
$ docker save nvcr.io/nvidia/repository:tag > framework.tar
```

6. Transfer the image to the air-gapped system using removable media such as a USB flash drive.

7. Load the NVIDIA Docker image.

```
$ docker load -i framework.tar
```

8. Verify the image is on your system.

```
$ docker images
```

Appendix B. Safety

This section provides information about how to safely use the DGX A100 system.

B.1. Safety Information

To reduce the risk of bodily injury, electrical shock, fire, and equipment damage, read this document and observe all warnings and precautions in this guide before installing or maintaining your server product.

In the event of a conflict between the information in this document and information provided with the product or on the website for a particular product, the product documentation takes precedence.

Your server should be integrated and serviced only by technically qualified persons.

You must adhere to the guidelines in this guide and the assembly instructions in your server manuals to ensure and maintain compliance with existing product certifications and approvals. Use only the described, regulated components specified in this guide. Use of other products or components will void the UL Listing and other regulatory approvals of the product and may result in noncompliance with product regulations in the region(s) in which the product is sold.

B.2. Safety Warnings and Cautions

To avoid personal injury or property damage, before you begin installing the product, read, observe, and adhere to all of the following safety instructions and information.

The following safety symbols may be used throughout the documentation and may be marked on the product and the product packaging.

Symbol	Meaning
CAUTION	Indicates the presence of a hazard that may cause minor personal injury or property damage if the CAUTION is ignored.
WARNING	Indicates the presence of a hazard that may result in serious personal injury if the WARNING is ignored.

Symbol	Meaning
	<p>Indicates potential hazard if indicated information is ignored.</p>
	<p>Indicates shock hazards that result in serious injury or death if safety instructions are not followed.</p>
	<p>Indicates hot components or surfaces</p>
	<p>Indicates do not touch fan blades, may result in injury.</p>
	<ul style="list-style-type: none"> ▶ Shock hazard: The product might be equipped with multiple power cords. To remove all hazardous voltages, disconnect all power cords. ▶ High leakage current ground (earth) connection to the Power Supply is essential before connecting the supply.
	<p>Recycle the battery.</p>
	<p>The rail racks are designed to carry only the weight of the server system. Do not use rail-mounted equipment as a workspace. Do not place additional load onto any rail-mounted equipment.</p>

B.3. Intended Application Uses

This product was evaluated as Information Technology Equipment (ITE), which may be installed in offices, schools, computer rooms, and similar commercial type locations.

The suitability of this product for other product categories and environments (such as medical, industrial, residential, alarm systems, and test equipment), other than an ITE application, may require further evaluation.

B.4. Site Selection

Here is some information about how to select the correct site for the DGX A100 system.

Choose a site that is:

- ▶ Clean, dry, and free of airborne particles (other than normal room dust).
- ▶ Well-ventilated and away from sources of heat including direct sunlight and radiators.
- ▶ Away from sources of vibration or physical shock.
- ▶ In regions that are susceptible to electrical storms, we recommend you plug your system into a surge suppressor and disconnect telecommunication lines to your modem during an electrical storm.
- ▶ Provided with a properly grounded wall outlet.
- ▶ Provided with sufficient space to access the power supply cord(s), because they serve as the product's main power disconnect.

B.5. Equipment Handling Practices

Here is some information about how to handle the equipment.

To reduce the risk of personal injury or equipment damage, do the following:

- ▶ Conform to local occupational health and safety requirements when moving and lifting equipment.
- ▶ Use mechanical assistance or other suitable assistance when moving and lifting equipment.

B.6. Electrical Precautions

Here is some information about electrical precautions.

Power and Electrical Warnings



CAUTION: The power button, indicated by the stand-by power marking, DOES NOT completely turn off the system AC power; standby power is active whenever the system is plugged in. To remove power from system, you must unplug the AC power cord from the wall outlet. Make sure all AC power cords are unplugged before you open the chassis, or add or remove any non hot-plug components.

Do not attempt to modify or use an AC power cord if it is not the exact type required. A separate AC cord is required for each system power supply.

Some power supplies in servers use Neutral Pole Fusing. To avoid risk of shock use caution when working with power supplies that use Neutral Pole Fusing.

The power supply in this product contains no user-serviceable parts. Do not open the power supply. Hazardous voltage, current and energy levels are present inside the power supply. Return to manufacturer for servicing.

When replacing a hot-plug power supply, unplug the power cord to the power supply being replaced before removing it from the server.

To avoid risk of electric shock, turn off the server and disconnect the power cords, telecommunications systems, networks, and modems attached to the server before opening it.

Power Cord Warnings



CAUTION: To avoid electrical shock or fire, check the power cord(s) that will be used with the product as follows:

- ▶ Do not attempt to modify or use the AC power cord(s) if they are not the exact type required to fit into the grounded electrical outlets.
- ▶ The power cord(s) must meet the following criteria:
 - ▶ The power cord must have an electrical rating that is greater than that of the electrical current rating marked on the product.
 - ▶ The power cord must have safety ground pin or contact that is suitable for the electrical outlet.

- ▶ The power supply cord(s) is/ are the main disconnect device to AC power. The socket outlet(s) must be near the equipment and readily accessible for disconnection.
- ▶ The power supply cord(s) must be plugged into socket-outlet(s) that is /are provided with a suitable earth ground.

B.7. System Access Warnings

Here is some information about system access warnings for the DGX A100 system.

To avoid personal injury or property damage, the following safety instructions apply whenever accessing the inside of the product:

- ▶ Turn off all peripheral devices connected to this product.
- ▶ Turn off the system by pressing the power button to off.
- ▶ Disconnect the AC power by unplugging all AC power cords from the system or wall outlet.
- ▶ Disconnect all cables and telecommunication lines that are connected to the system.
- ▶ Retain all screws or other fasteners when removing access cover(s). Upon completion of accessing inside the product, refasten access cover with original screws or fasteners.
- ▶ Do not access the inside of the power supply. There are no serviceable parts in the power supply.
- ▶ Return to manufacturer for servicing.
- ▶ Power down the server and disconnect all power cords before adding or replacing any non hot-plug component.
- ▶ When replacing a hot-plug power supply, unplug the power cord to the power supply being replaced before removing the power supply from the server.



CAUTION: If the server has been running, any installed processor(s) and heat sink(s) may be hot.

Unless you are adding or removing a hot-plug component, allow the system to cool before opening the covers. To avoid the possibility of coming into contact with hot component(s) during a hot-plug installation, be careful when removing or installing the hot-plug component(s).



CAUTION: To avoid injury do not contact moving fan blades. Your system is supplied with a guard over the fan, do not operate the system without the fan guard in place.

B.8. Rack Mount Warnings

The following installation guidelines are required by UL to maintain safety compliance when installing your system into a rack.

The equipment rack must be anchored to an unmovable support to prevent it from tipping when a server or piece of equipment is extended from it. The equipment rack must be installed according to the rack manufacturer's instructions.

Install equipment in the rack from the bottom up with the heaviest equipment at the bottom of the rack.

Extend only one piece of equipment from the rack at a time.

You are responsible for installing a main power disconnect for the entire rack unit. This main disconnect must be readily accessible, and it must be labeled as controlling power to the entire unit, not just to the server(s).

To avoid risk of potential electric shock, a proper safety ground must be implemented for the rack and each piece of equipment installed in it.

Elevated Operating Ambient- If installed in a closed or multi-unit rack assembly, the operating ambient temperature of the rack environment may be greater than room ambient. Therefore, consideration should be given to installing the equipment in an environment compatible with the maximum ambient temperature (T_{ma}) specified by the manufacturer.

Reduced Air Flow -Installation of the equipment in a rack should be such that the amount of air flow required for safe operation of the equipment is not compromised.

Mechanical Loading- Mounting of the equipment in the rack should be such that a hazardous condition is not achieved due to uneven mechanical loading.

Circuit Overloading- Consideration should be given to the connection of the equipment to the supply circuit and the effect that overloading of the circuits might have on overcurrent protection and supply wiring. Appropriate consideration of equipment nameplate ratings should be used when addressing this concern.

Reliable Earthing- Reliable earthing of rack-mounted equipment should be maintained.

Particular attention should be given to supply connections other than direct connections to the branch circuit (for example, the use of power strips).

B.9. Electrostatic Discharge

Here is some information about how to handle electric discharges (ESD) in the DGX A100 system.



CAUTION: ESD can damage drives, boards, and other parts. We recommend that you perform all procedures at an ESD workstation. If one is not available, provide some ESD

protection by wearing an antistatic wrist strap attached to chassis ground (any unpainted metal surface) on your server when handling parts.

Always handle boards carefully. They can be extremely sensitive to ESO. Hold boards only by their edges. After removing a board from its protective wrapper or from the server, place the board component side up on a grounded, static free surface. Use a conductive foam pad if available but not the board wrapper. Do not slide board over any surface.

B.10. Other Hazards

Here is some information about other hazards.

CALIFORNIA DEPARTMENT OF TOXIC SUBSTANCES CONTROL:

Perchlorate Material – special handling may apply. See www.dtsc.ca.gov/perchlorate.

Perchlorate Material: Lithium battery (CR2032) contains perchlorate. Please follow instructions for disposal.

NICKEL



NVIDIA Bezel. The bezel's decorative metal foam contains some nickel. The metal foam is not intended for direct and prolonged skin contact. Please use the handles to remove, attach or carry the bezel. While nickel exposure is unlikely to be a problem, you should be aware of the possibility in case you're susceptible to nickel-related reactions.

Battery Replacement



CAUTION: There is the danger of explosion if the battery is incorrectly replaced. When replacing the battery, use only the battery recommended by the equipment manufacturer.

Dispose of batteries according to local ordinances and regulations. Do not attempt to recharge a battery.

Do not attempt to disassemble, puncture, or otherwise damage a battery.

更換電池警告:¶

警告¶

更換不正確之電池型式會有爆炸的風險請
依製造商說明書處理用過之電池.¶

Cooling and Airflow



CAUTION: Carefully route cables as directed to minimize airflow blockage and cooling problems. For proper cooling and airflow, operate the system only with the chassis covers installed.

Operating the system without the covers in place can damage system parts. To install the covers:

- ▶ Check first to make sure you have not left loose tools or parts inside the system.
- ▶ Check that cables, add-in cards, and other components are properly installed.
- ▶ Attach the covers to the chassis according to the product instructions.

The equipment is intended for installation only in a Server Room/ Computer Room where both these conditions apply:

- ▶ Access can only be gained by SERVICE PERSONS or by USERS who have been instructed about the reasons for the restrictions applied to the location and about any precautions that shall be taken.
- ▶ Access is through the use of a TOOL or lock and key, or other means of security, and is controlled by the authority responsible for the location.

Appendix C. Compliance

The NVIDIA DGX A100 Server is compliant with the regulations listed in this section.

C.1. United States

Federal Communications Commission (FCC) FCC Marking (Class A)

This device complies with part 15 of the FCC Rules. Operation is subject to the following two conditions: (1) this device may not cause harmful interference, and (2) this device must accept any interference received, including any interference that may cause undesired operation of the device.

NOTE: This equipment has been tested and found to comply with the limits for a Class A digital device, pursuant to part 15 of the FCC Rules. These limits are designed to provide reasonable protection against harmful interference when the equipment is operated in a commercial environment. This equipment generates, uses, and can radiate radio frequency energy and, if not installed and used in accordance with the instruction manual, may cause harmful interference to radio communications. Operation of this equipment in a residential area is likely to cause harmful interference in which case the user will be required to correct the interference at his own expense.

California Department of Toxic Substances Control: Perchlorate Material - special handling may apply. See www.dtsc.ca.gov/perchlorate.

C.2. United States/Canada

Explain what the concept is and why the reader should care about it in 50 words or fewer.

TÜV Rheinland of North America is accredited as a Nationally Recognized Testing Laboratory (NRTL), by OSHA (The Occupational Safety and Health Administration) in the United States, and as a Product Certification Body by SCC (Standards Council of Canada) in Canada. Refer to [https:// www.tuv.com/usa/en/ctuvus-certification.html](https://www.tuv.com/usa/en/ctuvus-certification.html).

cTUVus Mark



C.3. Canada

Innovation, Science and Economic Development Canada (ISED) CAN ICES-3(A)/NMB-3(A)

The Class A digital apparatus meets all requirements of the Canadian Interference-Causing Equipment Regulation.

Cet appareil numérique de la class A respecte toutes les exigences du Règlement sur le matériel brouilleur du Canada.

C.4. CE

European Conformity; Conformité Européenne (CE)



This is a Class A product. In a domestic environment this product may cause radio frequency interference in which case the user may be required to take adequate measures.

This device bears the CE mark in accordance with Directive 2014/53/EU. This device complies with the following Directives:

- ▶ EMC Directive A, I.T.E Equipment.
- ▶ Low Voltage Directive for electrical safety.
- ▶ RoHS Directive for hazardous substances.
- ▶ Energy-related Products Directive (ErP).

The full text of EU declaration of conformity is available at the following internet address: www.nvidia.com/support.

A copy of the Declaration of Conformity to the essential requirements may be obtained directly from NVIDIA GmbH (Bavaria Towers – Blue Tower, Einsteinstrasse 172, D-81677 Munich, Germany).

C.5. Australia and New Zealand

Australian Communications and Media Authority



This product meets the applicable EMC requirements for Class A, I.T.E equipment.

C.6. Brazil

INMETRO



C.7. Japan

Voluntary Control Council for Interference (VCCI)



この装置は、クラスA機器です。この装置を住宅環境で使用すると電波妨害を引き起こすことがあります。この場合には使用者が適切な対策を講ずるよう要求されることがあります。

VCCI - A

This is a Class A product.

In a domestic environment this product may cause radio interference, in which case the user may be required to take corrective actions. VCCI-A.

2008年、日本における製品含有表示方法、JISC0950が公示されました。製造事業者は、2006年7月1日以降に販売される電気・電子機器の特定化学物質の含有に付きまして情報提供を義務付けられました。製品の部材表示に付きましては、以下をご覧ください。¶

A Japanese regulatory requirement, defined by specification JIS-C-0950, 2008, mandates that manufacturers provide Material Content Declarations for certain categories of electronic products offered for sale after July 1, 2006.¶

To view the JIS-C-0950 material declaration for this product, visit¶

Japan RoHS Material Content Declaration

日本工業規格 JIS-C 0950:2008 により、2006年7月1日以降に販売される特定分野の電気および電子機器について、製造者による含有物質の表示が義務付けられます。

機器名称：リノバ

主な分類	特定化学物質記号					
	Pb	Hg	Cd	Cr(VI)	PBB	PBDE
筐体	除外項目	0	0	0	0	0
プリント基板	除外項目	0	0	0	0	0
プロセッサ	除外項目	0	0	0	0	0
マザーボード	除外項目	0	0	0	0	0
電源	除外項目	0	0	0	0	0
システムメモリ	除外項目	0	0	0	0	0
ハードディスクドライブ	除外項目	0	0	0	0	0
機械部品 (ファン、ヒートシンク、ベゼル...)	除外項目	0	0	0	0	0
ケーブル/コネクタ	除外項目	0	0	0	0	0
はんだ付け材料	0	0	0	0	0	0
フラックス、クリームはんだ、ラベル...その他消耗品	0	0	0	0	0	0

注：

- 「0」は、特定化学物質の含有率が日本工業規格 JIS-C 0950:2008 に記載されている含有率基準値より低いことを示します。
- 「除外項目」は、特定化学物質が含有マークの除外項目に該当するため、特定化学物質について、日本工業規格 JIS-C 0950:2008 に基づく含有マークの表示が不要であることを示します。
- 「0.1wt% 超」または「0.01wt% 超」は、特定化学物質の含有率が日本工業規格 JIS-C 0950:2008 に記載されている含有率基準値を超過していることを示します。

A Japanese regulatory requirement, defined by specification JIS C 0950: 2008, mandates that manufacturers provide Material Content Declarations for certain categories of electronic products offered for sale after July 1, 2006.

Product Model Number: P3687 Server

Major Classification	Symbols of Specified Chemical Substance					
	Pb	Hg	Cd	Cr(VI)	PBB	PBDE
Chassis	Exempt	0	0	0	0	0
PCA	Exempt	0	0	0	0	0
Processor	Exempt	0	0	0	0	0
Motherboard	Exempt	0	0	0	0	0
Power supply	Exempt	0	0	0	0	0

System memory	Exempt	0	0	0	0	0
Hard drive	Exempt	0	0	0	0	0
Mechanical parts (fan, heat sink, bezel...)	Exempt	0	0	0	0	0
Cables/Connectors	Exempt	0	0	0	0	0
Soldering material	0	0	0	0	0	0
Flux, Solder Paste, label and other consumable materials	0	0	0	0	0	0

Notes:

- "0" indicates that the level of the specified chemical substance is less than the threshold level specified in the standard, JIS C 0950: 2008.
- "Exempt" indicates that the specified chemical substance is exempt from marking and it is not required to display the marking for that specified chemical substance per the standard, JIS C 0950: 2008.
- "Exceeding 0.1wt%" or "Exceeding 0.01wt%" is entered in the table if the level of the specified chemical substance exceeds the threshold level specified in the standard, JIS C 0950: 2008.

C.8. South Korea

Korean Agency for Technology and Standards (KATS)



R-R-WT1-P3687

<p>A급 기기 (업무용 방송통신기자재)</p>	<p>이 기기는 업무용(A급) 전자파적합기기로서 판매자 또는 사용자는 이 점을 주의하시기 바라며, 가정외의 지역에서 사용하는 것을 목적으로 합니다.</p>
--------------------------------	--

Class A Equipment (Industrial Broadcasting & Communication Equipment). This equipment Industrial (Class A) electromagnetic wave suitability equipment and seller or user should take notice of it, and this equipment is to be used in the places except for home.

Korea RoHS Material Content Declaration

확인 및 평가 양식은 제품에 포함 된 유해 물질의 허용 기준의 준수에 관한			
문 준비	상호:	엔비디아홍콩홀딩즈 리미티드(영입소)	법인등록번호: 110181-0036373
	대표자성명	카렌테레사벤즈	사업자등록번호: 120-84-06711
	주소	서울특별시 강남구 영동대로 511, 2101호 (삼성동,	
제품 내용			
제품의 종류	해당없음	제품명(규격)	해당없음
세부모델명(번호)	해당없음	제품출시일	해당없음
제품의 종량	해당없음	제조, 수입업자	엔비디아
엔비디아의 그래픽 카드제품은 전기 전자제품 및 자동차의 자원순환에 관한 법률 시행령 제 11조 제 1항에 의거한 법 시행령규칙 제 3조에따른 유해물질함유 기준을 확인 및 평가한 결과, 이를 준수하였음을 공표합니다.			
구비서류: 없음			
작성방법			
① 제품의 종류는 "전기·전자제품 및 자동차의 자원순환에 관한 법률 시행령" 제 8조 제 1항 및 제 2항에 따른 품목별로 구분하여 기재합니다.			
② 전기 전자 제품의 경우 모델명 (번호), 자동차의 경우, 제원관리번호를 기재합니다.			
③ 해당제품의 제조업자 또는 수입업자를 기재합니다.			

Confirmation and Evaluation Form Concerning the Adherence to Acceptable Standards of Hazardous Materials Contained in Products			
Statement Prepared by	Company Name:	Nvidia HongKong Holding Ltd.Korea branch	Corporate Identification Number: 110181-0036373
	Name of Company Representative:	Karen Theresa Burns	Business Registration Number: 120-84-06711
	Address	2788 San Tomas Expressway, Santa Clara, CA 95051	
Product Information			
Product Category:	N/A	Name of Product:	N/A
Detailed Product Model Name (Number):	N/A	Date of first market release:	N/A
Weight of Product:	N/A	Manufacturer and/or Importer:	NVIDIA Corporation
This for is publicly certify That NVIDIA Company has undergone the confirmation and evaluation procedures for the acceptable amounts of hazardous materials contained in graphic card according to the regulations stipulated in Article 3 of the 'Status on the Recycling of Electrical and Electronic Products, and Automobiles' and that company has graphic card adhered to the Enforcement Regulations of Article 11, Item 1 of the statute.			
Attachment: None			
* Preparing the Form			
① Please indicate the product category according to the categories listed in Article 8, Items 1 and 2 of the ' Enforcement Ordinance of the Statute on the Recycling of Electrical, Electronic and Automobile Materials'			
② For electrical and electronic products, please indicate the Model Name (and number). For automobiles, please indicate the Vehicle Identification Number.			
③ Please indicate the name of manufacturer and/or importer of the product.			

C.9. China

China Compulsory Certificate

No certification is needed for China. The NVIDIA DGX A100 is a server with power consumption greater than 1.3 kW.

China RoHS Material Content Declaration



产品中有毒物质的名称及含量
The Table of Hazardous Substances and their Content
根据中国《电器电子产品有害物质限制使用管理办法》

as required by China's Management Methods for Restricted of Hazardous Substances Used in Electrical and Electronic Products

部件名称 Parts	有毒物质 Hazardous Substances					
	铅 (Pb)	汞 (Hg)	镉 (Cd)	六价铬 (Cr(VI))	多溴联苯 (PBB)	多溴联苯醚 (PBDE)
机箱 Chassis	X	0	0	0	0	0
印刷电路部件 PCA	X	0	0	0	0	0
处理器 Processor	X	0	0	0	0	0
主板 Motherboard	X	0	0	0	0	0
电源设备 Power supply	X	0	0	0	0	0
存储设备 System memory	X	0	0	0	0	0
硬盘驱动器 Hard drive	X	0	0	0	0	0
机械部件 (风扇、散热器、面板等) Mechanical parts (fan, heat sink, bezel...)	X	0	0	0	0	0
线材/连接器 Cables/Connectors	X	0	0	0	0	0

焊接金属 Soldering material	0	0	0	0	0	0
助焊剂，锡膏，标签及其他耗材 Flux, Solder Paste, label and other consumable materials	0	0	0	0	0	0

本表格依据SJ/T 11364-2014 的规定编制
The table according to SJ/T 11364-2014

O：表示该有害物质在该部件所有均质材料中的含量均在GB/T 26572-2011 标准规定的限量要求以下。
O: Indicates that this hazardous substance contained in all of the homogeneous materials for this part is below the limit requirement in GB/T 26572-2011.

X：表示该有害物质至少在该部件的某一均质材料中的含量超出GB/T 26572-2011 标准规定的限量要求。
X: Indicates that this hazardous substance contained in at least one of the homogeneous materials used for this part is above the limit requirement in GB/T 26572-2011.

此表中所有名称中含“X”的部件均符合欧盟 RoHS 立法。
All parts named in this table with an “X” are in compliance with the European Union’s RoHS Legislation.

Note: The referenced Environmental Protection Use Period Marking was determined according to normal operating use conditions of the product such as temperature and humidity.

C.10. Taiwan

Bureau of Standards, Metrology & Inspection (BSMI)



警告使用者：
此為甲類資訊技術設備，於居住環境中使用時，可能會造成射頻擾動，在此種情況下，使用者會被要求採取某些適當的對策

報驗義務人：

香港商輝達香港控股有限公司台灣分公司 · 統一編號：80022300

臺北市內湖區基湖路8號。

Taiwan RoHS Material Content Declaration

限制物质含量标识要求声明表 Declaration of the presence condition of the Restricted Substances Marking						
设备名称: DCX 服务器 Equipment Name: DCX Server						
单元 Parts	受限制物质及其化学符号 Restricted substances and its chemical symbols					
	铅 (Pb)	汞 (Hg)	镉 (Cd)	六价铬 (Cr(VI))	多溴联苯 (PBB)	多溴二苯醚 (PBDE)
机箱 Chassis	-	0	0	0	0	0
印刷电路板 PCB	-	0	0	0	0	0
处理器 Processor	-	0	0	0	0	0
主板 Motherboard	-	0	0	0	0	0
电源设备 Power supply	-	0	0	0	0	0
存储器 System memory	-	0	0	0	0	0
硬盘驱动器 Hard drive	-	0	0	0	0	0
机械部件 (风扇、散热器、支架等) Mechanical parts (fan, heat sink, base...)	-	0	0	0	0	0
线材/连接器 Cables/Connectors	-	0	0	0	0	0
焊接材料 Soldering material	0	0	0	0	0	0
焊料、焊膏、锡膏及焊料材料 Flux, Solder Paste, label and other consumable materials	0	0	0	0	0	0

备注 1: 0: 表示该物质在材料中的含量百分比未超过参考值。
 Note 1: 0: indicates that the percentage content of the restricted substance does not exceed the percentage of reference value of presence.
 备注 2: -: 表示该物质在材料中未检出。
 Note 2: -: indicates that the restricted substance corresponds to the exemption.
 此表中所有名称中的“*”号均表示符合欧盟 RoHS 立法。
 All parts named in this table with “*” are in compliance with the European Union's RoHS Legislation.
 注: 本表格中的限制物质含量标识是根据产品在正常操作条件下的使用条件确定的。
 Note: The referenced Environmental Protection Use Period Marking was determined according to normal operating use conditions of the product such as temperature and humidity.

C.11. Russia/Kazakhstan/Belarus

Customs Union Technical Regulations (CU TR)



This device complies with the technical regulations of the Customs Union (CU TR)

ТЕХНИЧЕСКИЙ РЕГЛАМЕНТ ТАМОЖЕННОГО СОЮЗА О безопасности низковольтного оборудования (ТР ТС 004/2011)

ТЕХНИЧЕСКИЙ РЕГЛАМЕНТ ТАМОЖЕННОГО СОЮЗА Электромагнитная совместимость технических средств (ТР ТС 020/2011)

Технический регламент Евразийского экономического союза "Об ограничении применения опасных веществ в изделиях электротехники и радиоэлектроники" (ТР ЕАЭС 037/2016)

Federal Agency of communication (FAC)

This device complies with the rules set forth by Federal Agency of Communications and the Ministry of Communications and Mass Media.

Federal Security Service notification has been filed.

C.12. Israel

SII

ודא שלמות ותקינות כבל החשמל והתקע אין להכניס או להוציא את התקע מרשת החשמל בידיים רטובות . אין לפתוח את המכשיר , במקרה של בעיה כלשהי יש לפנות למעבדת השירות הקרובה. יש להרחיק את המכשיר מנזלים . במקרה של ריח מוזר, רעשים שמקורם במכשיר , יש לנתקו מיידית מרשת החשמל ולפנות למעבדת שירות המכשיר מיועד לשימוש בתוך המבנה , ולא לשימוש חיצוני ולא לשימוש בסביבה לחה. אין לחתוך, לשבור, ולעקם את הכבל החשמל. אין להניח חפצים על הכבל החשמל או להניח לו להתחמם יתר על המידה , שכן עלול לגרום לנזק, דליקה או התחשמלות . יש להקפיד לחזק את התקן הניתוק במצב תפעולי מוכן לשימוש. אזהרה: אין להחליף את כבל הזינה בתחליפים לא מקוריים, חיבור לקוי עלול לגרום להתחשמלות המשתמש. בשימוש על כבל מאריך יש לוודא תקינות מוליך הארקה שבכבל .

C.13. India

Concept definition.

Bureau of India Standards (BIS)



Authenticity may be verified by visiting the Bureau of Indian Standards website at <http://www.bis.gov.in>.

India RoHS Compliance Statement

This product, as well as its related consumables and spares, complies with the reduction in hazardous substances provisions of the "India E-waste (Management and Handling) Rule 2016". It does not contain lead, mercury, hexavalent chromium, polybrominated biphenyls or polybrominated diphenyl ethers in concentrations exceeding 0.1 weight % and 0.01 weight % for cadmium, except for where allowed pursuant to the exemptions set in Schedule 2 of the Rule.

C.14. South Africa

South African Bureau of Standards (SABS)

This device complies with the following SABS Standards:

SANS 2332: 2017/CISPR 32:2015 SANS 2335:2018/ CISPR 35:2016

National Regulator of Compulsory Specification (NRCS)

This device complies with following standard under VC 8055:

SANS IEC 60950-1

C.15. Great Britain (England, Wales, and Scotland)

UK Conformity Assessed



This device complies with the following Regulations:

- ▶ SI 2016/1091: Electromagnetic Compatibility (EMC)
- ▶ SI 2016/1101: The Low Voltage Electrical Equipment (Safety)
- ▶ SI 2012/3032: The Restriction of the Use of Certain Hazardous Substances in Electrical and Electronic Equipment (As Amended)

A copy of the Declaration of Conformity to the essential requirements may be obtained directly from NVIDIA Ltd. (100 Brook Drive, 3rd Floor Green Park, Reading RG2 6UJ, United Kingdom)

Notice

This document is provided for information purposes only and shall not be regarded as a warranty of a certain functionality, condition, or quality of a product. NVIDIA Corporation ("NVIDIA") makes no representations or warranties, expressed or implied, as to the accuracy or completeness of the information contained in this document and assumes no responsibility for any errors contained herein. NVIDIA shall have no liability for the consequences or use of such information or for any infringement of patents or other rights of third parties that may result from its use. This document is not a commitment to develop, release, or deliver any Material (defined below), code, or functionality.

NVIDIA reserves the right to make corrections, modifications, enhancements, improvements, and any other changes to this document, at any time without notice.

Customer should obtain the latest relevant information before placing orders and should verify that such information is current and complete.

NVIDIA products are sold subject to the NVIDIA standard terms and conditions of sale supplied at the time of order acknowledgement, unless otherwise agreed in an individual sales agreement signed by authorized representatives of NVIDIA and customer ("Terms of Sale"). NVIDIA hereby expressly objects to applying any customer general terms and conditions with regards to the purchase of the NVIDIA product referenced in this document. No contractual obligations are formed either directly or indirectly by this document.

NVIDIA products are not designed, authorized, or warranted to be suitable for use in medical, military, aircraft, space, or life support equipment, nor in applications where failure or malfunction of the NVIDIA product can reasonably be expected to result in personal injury, death, or property or environmental damage. NVIDIA accepts no liability for inclusion and/or use of NVIDIA products in such equipment or applications and therefore such inclusion and/or use is at customer's own risk.

NVIDIA makes no representation or warranty that products based on this document will be suitable for any specified use. Testing of all parameters of each product is not necessarily performed by NVIDIA. It is customer's sole responsibility to evaluate and determine the applicability of any information contained in this document, ensure the product is suitable and fit for the application planned by customer, and perform the necessary testing for the application in order to avoid a default of the application or the product. Weaknesses in customer's product designs may affect the quality and reliability of the NVIDIA product and may result in additional or different conditions and/or requirements beyond those contained in this document. NVIDIA accepts no liability related to any default, damage, costs, or problem which may be based on or attributable to: (i) the use of the NVIDIA product in any manner that is contrary to this document or (ii) customer product designs.

No license, either expressed or implied, is granted under any NVIDIA patent right, copyright, or other NVIDIA intellectual property right under this document. Information published by NVIDIA regarding third-party products or services does not constitute a license from NVIDIA to use such products or services or a warranty or endorsement thereof. Use of such information may require a license from a third party under the patents or other intellectual property rights of the third party, or a license from NVIDIA under the patents or other intellectual property rights of NVIDIA.

Reproduction of information in this document is permissible only if approved in advance by NVIDIA in writing, reproduced without alteration and in full compliance with all applicable export laws and regulations, and accompanied by all associated conditions, limitations, and notices.

THIS DOCUMENT AND ALL NVIDIA DESIGN SPECIFICATIONS, REFERENCE BOARDS, FILES, DRAWINGS, DIAGNOSTICS, LISTS, AND OTHER DOCUMENTS (TOGETHER AND SEPARATELY, "MATERIALS") ARE BEING PROVIDED "AS IS." NVIDIA MAKES NO WARRANTIES, EXPRESSED, IMPLIED, STATUTORY, OR OTHERWISE WITH RESPECT TO THE MATERIALS, AND EXPRESSLY DISCLAIMS ALL IMPLIED WARRANTIES OF NONINFRINGEMENT, MERCHANTABILITY, AND FITNESS FOR A PARTICULAR PURPOSE. TO THE EXTENT NOT PROHIBITED BY LAW, IN NO EVENT WILL NVIDIA BE LIABLE FOR ANY DAMAGES, INCLUDING WITHOUT LIMITATION ANY DIRECT, INDIRECT, SPECIAL, INCIDENTAL, PUNITIVE, OR CONSEQUENTIAL DAMAGES, HOWEVER CAUSED AND REGARDLESS OF THE THEORY OF LIABILITY, ARISING OUT OF ANY USE OF THIS DOCUMENT, EVEN IF NVIDIA HAS BEEN ADVISED OF THE POSSIBILITY OF SUCH DAMAGES. Notwithstanding any damages that customer might incur for any reason whatsoever, NVIDIA's aggregate and cumulative liability towards customer for the products described herein shall be limited in accordance with the Terms of Sale for the product.

Trademarks

NVIDIA, the NVIDIA logo, DGX, DGX-1, DGX-2, DGX A100, DGX H100, DGX, H800, DGX A800, DGX Station, DGX Station A100, and DGX Station A800 are trademarks and/or registered trademarks of NVIDIA Corporation in the United States and other countries. Other company and product names may be trademarks of the respective companies with which they are associated.

Copyright

© 2023 NVIDIA Corporation & Affiliates. All rights reserved.